

# Defibtech DDU-2400 and DDU-2450 Automated External Defibrillator



## User Manual

**PRESS "ON"  
BUTTON**

**1**



**APPLY PADS  
FOLLOW AED  
INSTRUCTIONS**

**2**

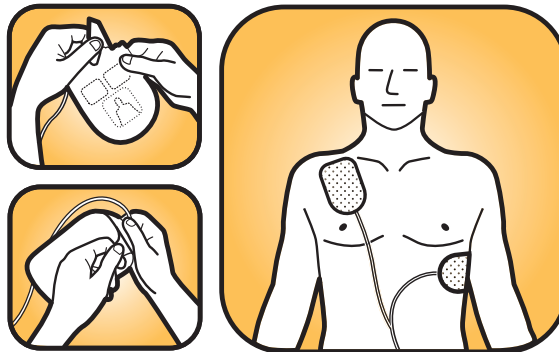

**IF INSTRUCTED,  
PRESS "SHOCK"  
BUTTON**

**3**



## Notices

Defibtech, LLC shall not be liable for errors contained herein or for incidental or consequential damages in connection with the furnishing, performance, or use of this material.

Information in this document is subject to change without notice. Names and data used in the examples are fictitious unless otherwise noted.

## Limited Warranty

The "Limited Warranty" shipped with Defibtech AED products serves as the sole and exclusive warranty provided by Defibtech, LLC, with respect to the products contained herein.

## Copyright



Copyright © 2012 Defibtech, LLC

All rights reserved. Copyright questions should be directed to Defibtech. For contact information, refer to [Chapter 14](#) of this manual.



**Federal Law (USA) restricts this device  
to sale by or on the order of a physician.**

# Contents

<b>1</b>	<b>Introduction To The DDU-2400/2450 AED</b> .....	<b>6</b>
1.1	Overview .....	6
1.2	The Defibtech DDU-2400/2450 AED .....	8
1.3	Indications .....	10
1.4	Operator Training Requirements .....	10
<b>2</b>	<b>Dangers, Warnings, And Cautions</b> .....	<b>11</b>
2.1	 Dangers .....	11
2.2	 Warnings .....	11
2.3	 Cautions .....	12
<b>3</b>	<b>Setting Up The DDU-2400/2450 AED</b> .....	<b>13</b>
3.1	Overview .....	13
3.2	Connecting The Defibrillation Pads .....	13
3.3	Installing The Defibtech Data Card (DDC Card) (Optional) .....	14
3.4	Installing And Removing the Battery Pack .....	15
3.5	Checking The DDU-2400/2450 AED Status .....	15
3.6	Completing The Installation .....	16
3.7	Storing The DDU-2400/2450 AED .....	16
<b>4</b>	<b>Using The DDU-2400/2450 In AED Mode</b> .....	<b>17</b>
4.1	Overview .....	17
4.2	Preparation .....	19
4.3	Heart Rhythm Analysis .....	22
4.4	Delivering The Shock .....	22
4.5	CPR Period .....	22
4.6	Post Use Procedures .....	23
4.7	AED Mode Voice And Text Prompts .....	23
4.8	Operational Environment .....	27
<b>5</b>	<b>Manual Mode (DDU-2400 only)</b> .....	<b>28</b>
5.1	Entering Manual Mode .....	28
5.2	Exiting Manual Mode .....	28
5.3	Selecting Energy .....	29
5.4	Initiating Charge .....	29
5.5	Delivering The Shock .....	29
<b>6</b>	<b>ECG Monitor Mode</b> .....	<b>30</b>
6.1	Entering ECG Monitor Mode .....	30
6.2	Applying The Electrodes .....	30
6.3	Monitoring The Patient .....	31

Click any of the section headings above to be automatically re-directed to that page.  
See page references noted in green throughout this book for other interactive links.

<b>7</b>	<b>Maintenance And Troubleshooting</b>	<b>32</b>
7.1	Routine Unit Maintenance	32
7.2	Self-Tests	36
7.3	Cleaning	36
7.4	Storage	36
7.5	Operator's Checklist	37
7.6	Troubleshooting	38
7.7	Repair	39
<b>8</b>	<b>Maintenance Mode</b>	<b>40</b>
8.1	Overview	40
8.2	Navigation (in Maintenance Mode)	40
8.3	Entering Maintenance Mode	41
8.4	AED Main Menu Screen	41
8.5	AED Status Screen	41
8.6	AED Maintenance Screen	42
8.7	AED Options Screen	44
8.8	Rescue Options Screen	46
8.9	Help Topics Screen	48
<b>9</b>	<b>DDU-2400/2450 AED Accessories</b>	<b>49</b>
9.1	Defibrillation Pads	49
9.2	Battery Packs	49
9.3	Data Cards	49
9.4	USB Cable	50
9.5	ECG Monitoring Adaptor	50
<b>10</b>	<b>Event Viewing</b>	<b>51</b>
10.1	DefibView II	51
10.2	Defibtech Data Cards (DDC Cards)	51
10.3	Downloading The Internal Data Log	51
<b>11</b>	<b>Technical Specifications</b>	<b>52</b>
11.1	Defibtech DDU-2400/2450 AED	52
11.2	Battery Packs	58
11.3	Self-Adhesive Defibrillation Pads	58
11.4	ECG Monitoring Adaptor / Cable (optional)	58
11.5	Event Documentation	59
11.6	Defibtech Event Viewer	59
11.7	Recycling Information	59
11.8	Notice To European Union Customers	59
<b>12</b>	<b>Electromagnetic Conformity</b>	<b>60</b>
12.1	Guidance And Manufacturer's Declaration	60
<b>13</b>	<b>Glossary Of Symbols</b>	<b>63</b>
<b>14</b>	<b>Contacts</b>	<b>65</b>

Click any of the section headings above to be automatically re-directed to that page.  
See page references noted in green throughout this book for other interactive links.

# 1 Introduction To The DDU-2400/2450 AED

This User Manual provides information to guide trained operators in the use and maintenance of the Defibtech DDU-2400/2450 Semi-Automatic External Defibrillator (AED) and its accessories.

This chapter includes intended use, an overview of the AED, a discussion of when it should and should not be used, and information on operator training.

## 1.1 Overview

The DDU-2400/2450 AED is a Semi-Automatic External Defibrillator (AED) that is designed to be easy to use, portable, and battery powered. It has two primary user controls: the ON/OFF and SHOCK buttons, along with three softkey buttons for advanced mode features. Voice prompts, text prompts, and a display screen with visual prompts provide a simple interface for the operator. The DDU-2400/2450 AED is capable of recording event information, including ECG, audio data (optional), and SHOCK/NO-SHOCK recommendations.

The DDU-2400 AED and DDU-2450 AED include the following features:

- **DDU-2450** — Operates in AED Mode; includes patient ECG display and ECG monitor mode using an optional ECG Monitoring Adaptor.
- **DDU-2400** — Operates in AED Mode or Manual Mode; includes patient ECG display and ECG monitor mode using an optional ECG Monitoring Adaptor.

In **AED Mode**, when connected to a patient who is unconscious and not breathing, both models perform the following tasks:

- Prompts the operator, through audio, text, and video prompts, to prepare the patient for treatment.
- Automatically analyzes the patient's ECG.
- Determines whether a shockable rhythm is present.
- Charges the defibrillation capacitor and arms the SHOCK button if the AED detects a shockable rhythm.
- Prompts the operator to press the SHOCK button when the device is ready and a shock is recommended.
- Delivers a shock once the device has determined a shock is required and the SHOCK button has been pressed.
- Provides instructions to perform CPR.
- Repeats the process if additional shocks are required.
- Allows user to select between Video display or ECG display.

In **ECG Monitor Mode**, the AED allows display of the patient ECG using an optional 3-wire (LEAD II) ECG adaptor cable. ECG Monitor Mode provides a non-diagnostic display of the heart rhythm of a responsive or breathing patient for attended patient monitoring. While connected to the ECG adaptor cable, the AED disables its shock capability.

**Manual Mode (DDU-2400 only)** allows the user to override the automatic features of the AED. Manual Mode provides for operator selected energy levels along with charge, shock, and disarm features.

In AED Mode, the DDU-2400/2450 AED will NOT shock a patient automatically; it will only advise the operator. The SHOCK button is enabled only when a shockable rhythm is detected and the device is charged and ready to shock. Charging occurs automatically when the device detects a shockable rhythm. The operator must press the SHOCK button to initiate defibrillation. In Manual Mode, the operator is responsible for making the shock/no-shock decision, initiating charging and delivering the shock.

The DDU-2400/2450 AED uses two self-adhesive defibrillation pads (also known as electrode pads, electrodes, or pads) to monitor ECG signals and, if necessary, to deliver defibrillation energy to the patient. These pads are provided in a single-use, disposable package. The DDU-2400/2450 AED determines proper pad-to-patient contact by measuring the impedance between the two pads (impedance varies with the electrical resistance of the patient's body).

The DDU-2400/2450 AED user interface is clear and concise. It has two primary push-button controls and a display screen. Easily understandable voice messages and text and video prompts guide the operator through the use of the unit. The device communicates the status of the AED and of the patient to the operator. In Manual Mode, additional functions are provided through the three softkeys to the right of the display.

Defibrillation energy is delivered as an impedance compensated biphasic truncated exponential waveform. In AED Mode, the device delivers 150 Joules of defibrillation energy (into a 50-ohm load) when using adult defibrillation pads and 50 J of defibrillation energy (into a 50-ohm load) when using child/infant pads (also known as pediatric defibrillation pads). Energy delivered does not change significantly with patient impedance, although the duration of the generated waveform will vary. In Manual Mode, the DDU-2400 (only) offers user-selected energy levels from 25 to 200 Joules.

Defibrillation and AED operating power is supplied by a replaceable (non-rechargeable) battery pack that provides for long standby life and low maintenance operation. Each battery pack is marked with an expiration date.

The DDU-2400/2450 AED records event documentation internally and, optionally, on Defibtech Data Cards (DDC cards). The optional DDC card plugs into a slot in the AED and enables the AED to record event documentation and, optionally, audio data onto the card. Audio recording is selectable through configuration settings. Event documentation stored internally can be downloaded onto a DDC card for review.

A USB port is provided to perform maintenance and data recovery. The USB interface allows connection to a personal computer. Defibtech PC maintenance software helps support event downloading and unit maintenance operations.

## 1.2 The Defibtech DDU-2400/2450 AED

- A. Speaker.** The speaker projects the voice prompts when the DDU-2400/2450 AED is on. The speaker also emits a “beep” when the unit is off and has detected a condition that requires attention from the user or needs servicing.
- B. SHOCK Button.** This button will flash when a shock is recommended. Pressing this button will deliver a shock when the button is flashing. This button is disabled at all other times.
- C. Display Screen.** Color display panel used to display text and video prompts, messages, indicators for rescue, unit status, and maintenance operations. The display screen provides visual prompts, including CPR coaching, to assist rescuers with step-by-step instruction. In ECG Monitor Mode, the AED can also show an ECG trace.
- D. ON/OFF Button.** This button is used to turn the DDU-2400/2450 AED on and off.
- E. Pads Connector Socket.** The pads connector (item O) is inserted into this socket.
- F. Active Status Indicator (ASI).** The ASI indicates the current status of the AED. This indicator flashes green to indicate the unit is ready for use and flashes red to indicate unit needs attention from the user or needs servicing.
- G. Softkey Buttons.** Three context sensitive softkey buttons are used to navigate menus or select actions.
- H. USB Port.** The USB port is provided to perform data recovery and maintenance. Not to be used during rescue operation.
- I. Defibtech Data Card (DDC card).** This optional plug-in card provides enhanced storage capabilities to the AED.
- J. USB and Defibtech Data Card (DDC card) Access Door.** Behind the access door is the USB connector port and Defibtech Data Card (DDC card) slot.
- K. Unit Serial Number.** The unit’s serial number can be found on the back of the AED, above the battery pack opening.
- L. Battery Pack Opening.** This opening is where the battery pack is inserted into the unit.
- M. Battery Pack Eject Release Latch.** This release latch releases the battery pack from the DDU-2400/2450 AED.
- N. Pad Storage Area.** The pad storage area is found on the back of the AED allowing the pads to be stored in a pre-connected state for rapid deployment during an emergency.
- O. Pads Connector.** This connector attaches the patient pads to the unit at the Pads Connector Socket (item E).
- P. Defibrillation Pads.** The defibrillation pads are pads that are placed on the patient. The pads may be stored in the pad storage area (item N) on the back of the unit.
- Q. Defibrillation Pads Expiration Date (back side).** The defibrillation pads expiration date is located on the back side of the pads package. Do not use the pads after the printed date has passed.
- R. Battery Pack Serial Number.** The battery pack’s serial number is located on the label on the battery pack.
- S. Battery Pack.** The battery pack provides a replaceable main power source for the DDU-2400/2450 AED.
- T. Battery Pack Expiration Date.** The battery pack expiration date is printed on the label on the battery pack. Do not use the battery pack after the printed date has passed.
- U. ECG Monitoring Adaptor.** This optional adaptor provides a non-diagnostic ECG display of the patient’s heart rhythm for attended patient monitoring.



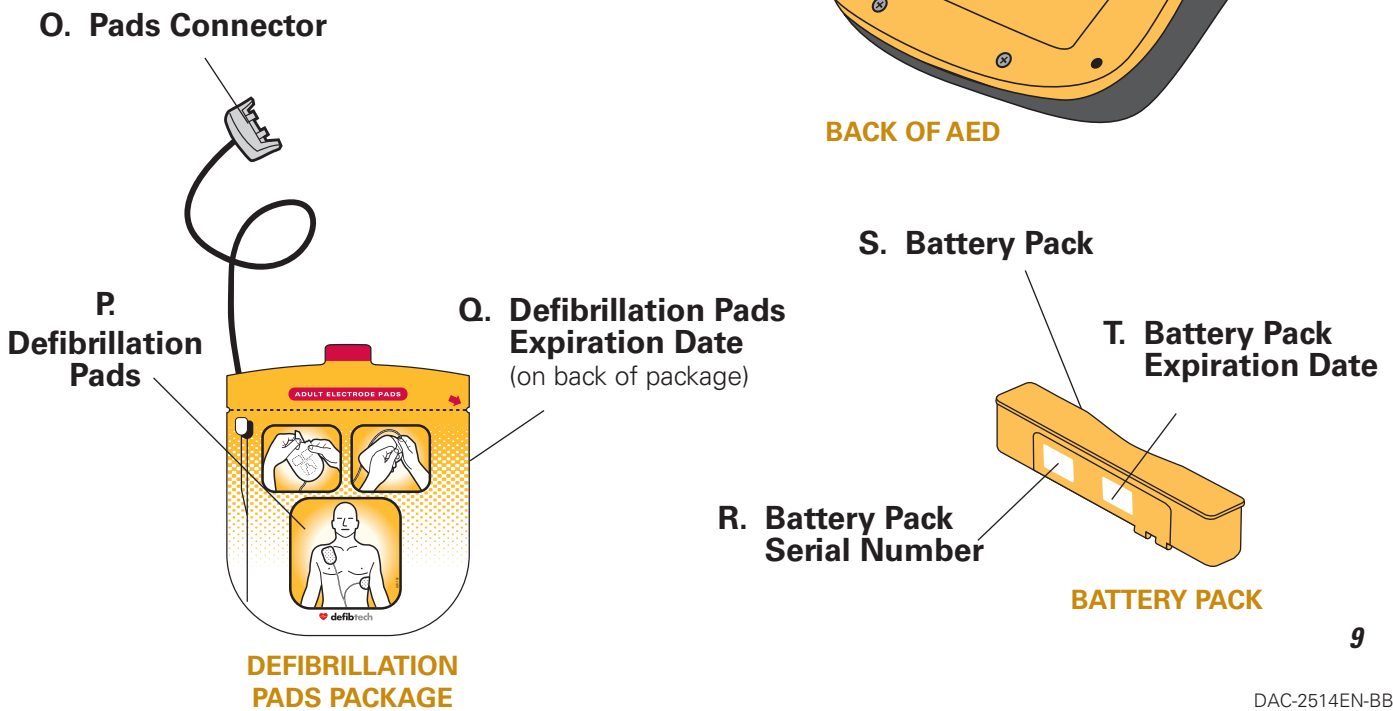
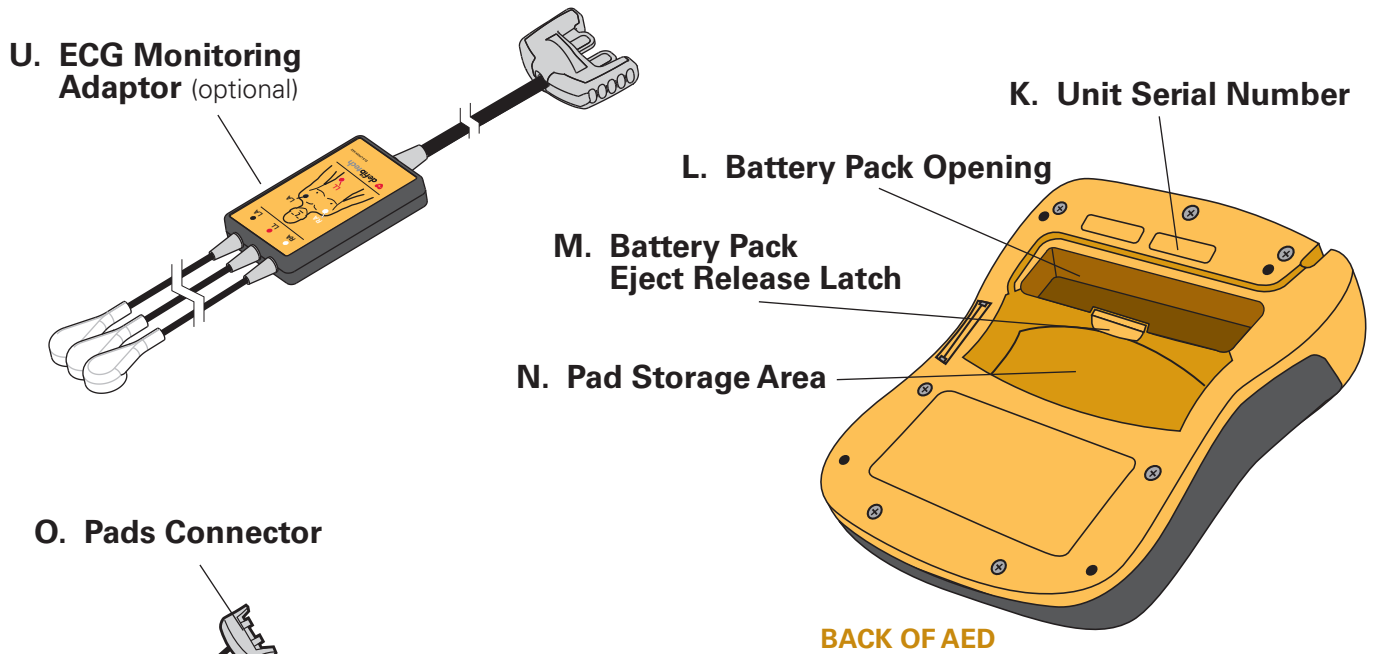
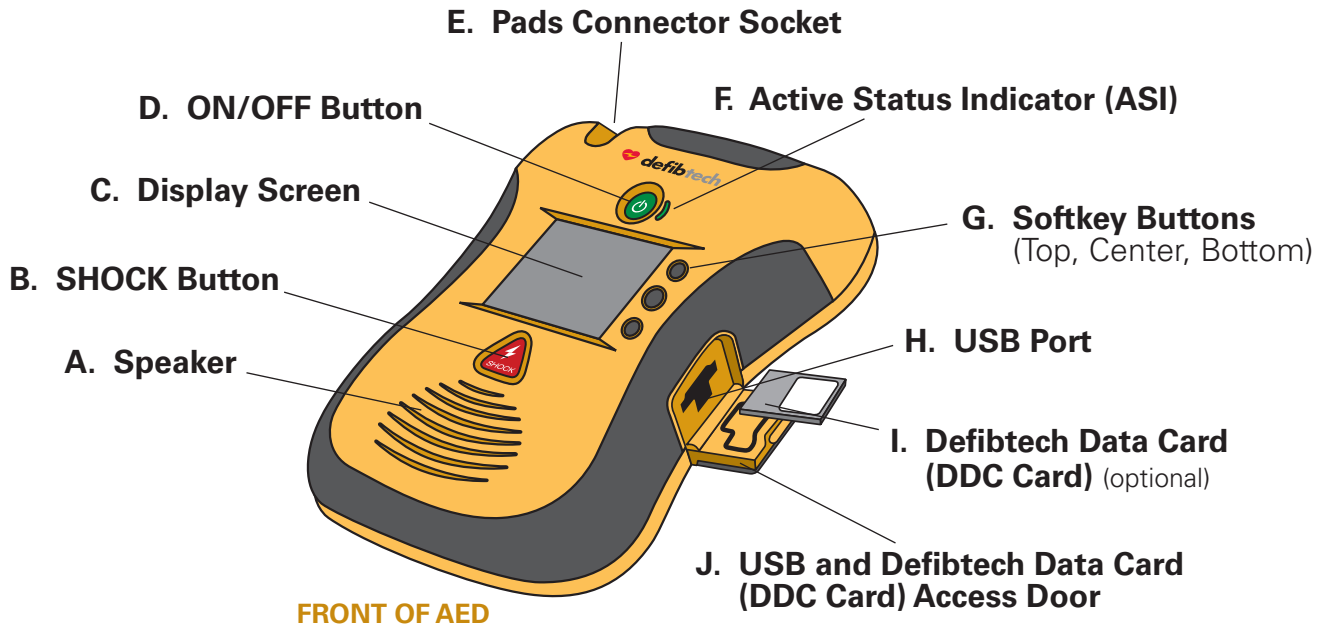

## 1.3 Indications

---

The DDU-2400/2450 Semi-Automatic External Defibrillator (AED) is indicated for use on victims of sudden cardiac arrest (SCA) who are:

- Unconscious and unresponsive
- Not breathing

For patients under 8 years old or less than 55 pounds (25kg), use child/infant electrode pads. Do not delay therapy to determine exact age or weight.

The DDU-2400/2450 AED must be used by or on the order of a physician.

## 1.4 Operator Training Requirements

---

In order to safely and effectively operate the DDU-2400/2450 AED, a person shall have met the following requirements:

- DDU-2400/2450 AED and/or defibrillation training as required by local, state, provincial, or national regulations.
- Any additional training as required by the authorizing physician.
- Thorough knowledge and understanding of the material presented in this User Manual.

Manual Mode (DDU-2400) is intended for use only by qualified medical personnel trained in advanced life support skills and ECG recognition who want to deliver a shock independent of AED Mode.

ECG Monitor Mode is intended to be used by personnel trained in basic life and/or advanced life support, or other physician-authorized emergency medical training. Users should be trained in ECG recognition to allow for rhythm and heart rate monitoring using standard ECG monitoring electrodes.

## 2 Dangers, Warnings, And Cautions

This chapter includes a list of danger, warning, and caution messages that relate to the Defibtech DDU-2400/2450 AED and its accessories. Many of these messages are repeated elsewhere in this User Manual and on the DDU-2400/2450 AED or accessories. The entire list is presented here for convenience.

### 2.1 **DANGERS:**

**Immediate hazards that will result in serious personal injury or death.**

- Hazardous electrical output. This equipment is for use only by qualified personnel.
- Potential for explosion. The DDU-2400/2450 AED is not suitable for use in an oxygen-enriched atmosphere or in the presence of a flammable anesthetic mixture with air or nitrous oxide.
- The DDU-2400/2450 AED has not been evaluated or approved for use in hazardous locations as defined in the National Electric Code standard. In compliance with IEC classification, the DDU-2400/2450 AED is not to be used in the presence of flammable substance/air mixtures.

### 2.2 **WARNINGS:**

**Conditions, hazards, or unsafe practices that may result in serious personal injury or death.**

- Improper use can cause injury. Use the DDU-2400/2450 AED only as instructed in the User Manual. The DDU-2400/2450 AED delivers electrical energy that can potentially cause death or injury if it is used or discharged improperly.
- Improper maintenance can cause the DDU-2400/2450 AED not to function. Maintain the DDU-2400/2450 AED only as described in the User Manual. The AED contains no user-serviceable parts — do not take the unit apart.
- Electrical Shock Hazard. Dangerous high voltages and currents are present. Do not open unit, remove cover (or back), or attempt repair. There are no user serviceable components in the DDU-2400/2450 AED. Refer servicing to qualified service personnel.
- Lithium battery packs are not rechargeable. Any attempt to recharge a lithium battery pack may result in fire or explosion.
- Do not immerse battery pack in water or other liquids. Immersion in fluids may result in fire or explosion.
- Do not let fluids get into the DDU-2400/2450 AED. Avoid spilling fluids on the AED or its accessories. Spilling fluids into the DDU-2400/2450 AED may damage it or cause a fire or shock hazard.
- Do not sterilize the DDU-2400/2450 AED or its accessories.
- Use only Defibtech disposable self-adhesive defibrillation pads, battery packs, and other accessories supplied by Defibtech or its authorized distributors. Substitution of non-Defibtech approved accessories may cause the device to perform improperly.
- Do not open sealed pads package until pads are to be used.
- Do not touch the patient during defibrillation. Defibrillation current can cause operator or bystander injury.
- Do not allow pads to touch metal objects or equipment in contact with the patient. Do not touch equipment connected to the patient during defibrillation. Disconnect other electrical equipment from the patient before defibrillation.
- Do not shock with defibrillation pads touching each other. Do not shock with gel surface exposed.
- Do not allow defibrillation pads to touch each other, or to touch other ECG electrodes, lead wires, dressings, transdermal patches, etc. Such contact can cause electrical arcing and patient skin burns during defibrillation and may divert defibrillating energy away from the heart.
- The defibrillation pads are intended for one-time use only and must be discarded after use. Reuse can lead to potential cross infection, improper performance of the device, inadequate delivery of therapy, and/or injury to the patient or operator.
- Avoid contact between parts of the patient's body and conductive fluids such as water, gel, blood or saline, and metal objects, which may provide unwanted pathways for defibrillating current.
- Disconnect all non-defibrillator proof equipment from the patient before defibrillation to prevent electrical shock hazard and potential damage to that equipment.

*WARNINGS (continued)*

- Aggressive or prolonged CPR to a patient with defibrillation pads attached can cause damage to the pads. Replace the defibrillation pads if they become damaged during use.
- Possible Radio Frequency (RF) interference from RF devices such as cellular phones and two-way radios can cause improper AED operation. Normally using a cell phone near the AED should not cause a problem; however, a distance of 2 meters (6 feet) between RF devices and the DDU-2400/2450 AED is recommended.
- CPR during analysis can cause incorrect or delayed diagnosis by the patient analysis system.
- Handling or transporting the patient during ECG analysis can cause incorrect or delayed diagnosis, especially if very low amplitude or low frequency rhythms are present. If the patient is being transported, stop vehicle before beginning ECG analysis.
- In patients with cardiac pacemakers, the DDU-2400/2450 AED may have reduced sensitivity and not detect all shockable rhythms. If you know the patient has an implanted pacemaker, do not place electrodes directly over an implanted device.
- During defibrillation, air pockets between the skin and defibrillation pads can cause patient skin burns. To help prevent air pockets, make sure self-adhesive defibrillation pads completely adhere to the skin. Do not use dried out or expired defibrillation pads.
- User-initiated and automatic self-tests are designed to assess the DDU-2400/2450 AED's readiness for use. However, no degree of testing can assure performance or detect abuse, damage, or a defect that occurred after the most recent test is completed.
- Use of damaged equipment or accessories may cause the device to perform improperly and/or result in injury to the patient or operator.
- The DDU-2400 Manual Mode Charge feature can deliver dangerous energy when used inappropriately; Manual Mode is intended for use only by authorized operators who have been specifically trained in cardiac rhythm recognition and in manual defibrillation therapy.
- Possible misinterpretation of ECG data. The frequency response of the LCD display is intended for basic ECG rhythm identification; it does not provide the resolution required for pacemaker pulse identification or accurate measurements, such as QRS duration and ST segment interpretation. For such purposes an ECG Monitor with an appropriate frequency response should be used.
- Follow voice prompts if the LCD screen becomes blank or unreadable.

### **2.3 CAUTIONS:**

#### **Conditions, hazards, or unsafe practices that may result in minor personal injury, damage to the DDU-2400/2450 AED, or loss of data.**

---

- Follow all battery pack labeling instructions. Do not install battery packs after the expiration date.
- Follow all defibrillation pad label instructions. Use defibrillation pads prior to their expiration date. Do not re-use defibrillation pads. Discard defibrillation pads after use (in the event of suspected pad malfunction, return pads to Defibtech for testing).
- Recycle or dispose of lithium battery packs in accordance with federal, state, and/or local laws. To avoid fire and explosion hazard, do not burn or incinerate the battery pack. Do not crush.
- Use and store the DDU-2400/2450 AED only within the range of environmental conditions specified in the technical specifications.
- If possible, disconnect the DDU-2400/2450 AED from the patient prior to use of other defibrillators.
- Do not connect the DDU-2400/2450 AED to a PC or other device (using the USB port) while the unit's electrodes are still connected to the patient.
- Using non-Defibtech Data Cards (DDC cards) may damage the unit and will void the warranty.
- Although the DDU-2400/2450 AED is designed for a wide variety of field use conditions, rough handling beyond specifications may result in damage to the unit.
- Federal Law (USA) restricts this device to sale by or on the order of a physician.

# 3 Setting Up The DDU-2400/2450 AED

This chapter describes the steps required to make your Defibtech DDU-2400/2450 AED operational. The DDU-2400/2450 AED is designed to be stored in a “ready” state. This chapter tells you how to make the device ready, so that if and when you need it, few steps are required to begin using the device.

## 3.1 Overview

The following components and accessories are included with your DDU-2400/2450 AED. Replacement and other accessories are detailed in the “*DDU-2400/2450 AED Accessories*” section. Before getting started, identify each component and ensure that your package is complete.

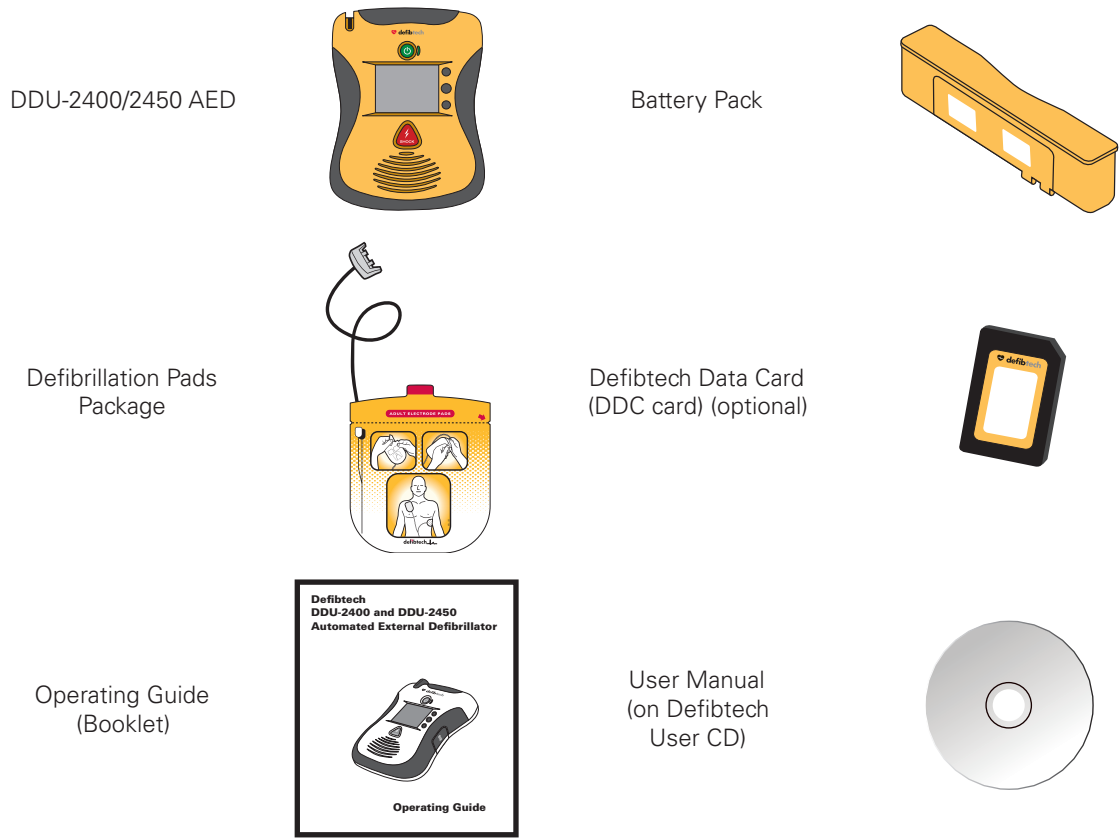

## 3.2 Connecting The Defibrillation Pads

The DDU-2400/2450 AED defibrillation pads are supplied sealed in a package with the connector and part of the cable exposed. This allows the pads to be stored in a pre-connected state for rapid deployment during an emergency.



**DO NOT** open the sealed pads package until the pads are to be used. The packaging should be opened only immediately prior to use, otherwise the pads may dry out and become non-functional.

**Note:** The DDU-2400/2450 AED is designed to be stored with the pads connector already installed. This simplifies the procedure for deploying and operating the device in an emergency.

First, check to ensure that the pads package has not expired. The expiration date is printed on the pad pouch and is also reported on the AED status screen. Do not use pads past expiration date. Discard expired pads.

### Connecting The Pads (continued)

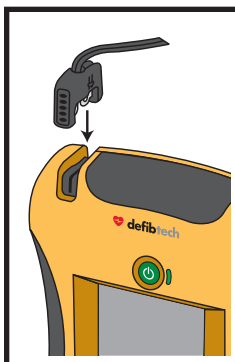
	<p>Insert the connector end of the defibrillation pad cable into the pads connector socket on the top-left corner of the DDU-2400/2450 AED as shown. Insert pads connector firmly until it is fully seated in the unit. The connector will only fit in one way – if the connector does not fit, rotate the connector before trying again.</p> <p>The connected pads package can then be stored in the pad storage slot in the back of the DDU-2400/2450 AED. After connecting the pads connector to the unit, push the pads package, rounded end first, with the pictures on the package facing out, into the pad holder compartment on the back of the AED. When the pads package is fully inserted, press the pad cable into the groove in the back of the unit to hold the cable in place and tuck any excess cable behind the pads package.</p>
---	---



The pads are intended for one time use only and must be discarded after use or if the package has been opened or damaged.

### 3.3 Installing The Defibtech Data Card (DDC Card) (Optional)

The Defibtech Data Card (DDC card) is used to store event and audio information collected by the AED. All DDU-2400/2450 AEDs will operate without DDC cards and will still store critical event information internally. DDC cards may be reviewed with a separate Defibtech PC-based software package. (Refer to the “*DefibView II*” section in Chapter 10 of this manual.)

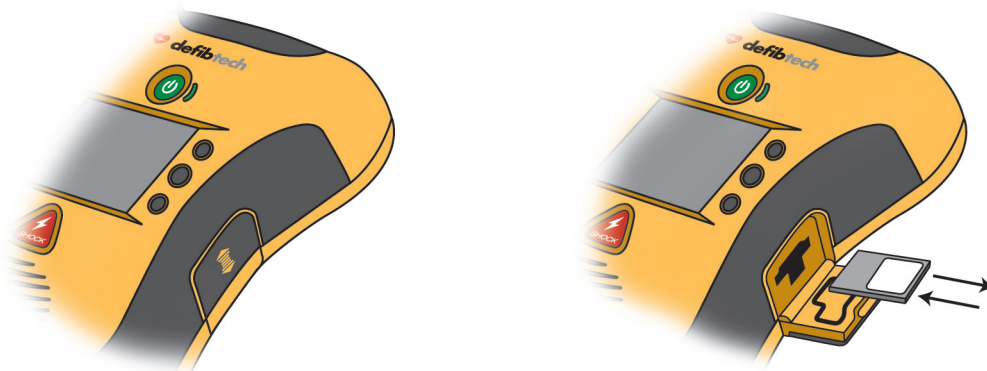

Before installing the DDC card, ensure the AED is turned OFF. Locate the data card/USB port access door on the right-hand side of the unit. Open the data card/USB port access door by slightly pushing and then sliding the door down to release the latch. The door will spring open. Insert the DDC card into the thin slot in the side of the AED centered above the USB port opening, notched end first, label side up, until it clicks into place. The card should be flush with the surface of the slot. If the card does not push in all the way, it may have been inserted upside down. In that case, remove the card, flip it over, and try inserting it again.

To remove the DDC card, press the card as far as it will go and then release. Upon release, the DDC card will be partially ejected and can be removed by pulling the DDC card the rest of the way out.

Close the data card/USB port access door by closing and then pushing the door up until the door latch engages.



Using non-Defibtech Data Cards (DDC cards) may damage the unit and will void the warranty.

### 3.4 Installing And Removing The Battery Pack

The battery pack provides power to the DDU-2400/2450 AED. Do not install the battery pack after the expiration date printed on the label. The battery pack is non-rechargeable.

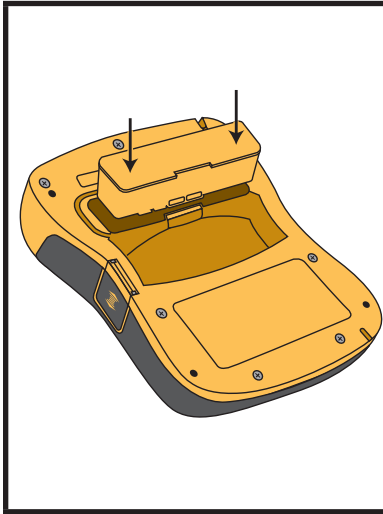

Before inserting the battery pack into the DDU-2400/2450 AED, ensure that the battery pack opening in the back of the AED is clean and clear of any foreign objects. Insert the battery pack into the opening in the back of the AED. Push the pack all the way in until the latch clicks. The battery pack will only fit in one way – if the battery pack does not fit, rotate the battery pack before trying again. Once fully inserted, the battery pack surface should be flush with the back of the AED.

Within moments of insertion the DDU-2400/2450 AED will turn on and run a battery pack insertion self-test.\* When the test is completed, the unit will report the status of the battery pack and shut down. Afterwards, the Active Status Indicator (ASI), adjacent to the ON/OFF button of the DDU-2400/2450 AED, will periodically flash. If the indicator flashes green, the AED and battery pack are ready for use. If the indicator flashes red, is solid red, or there is no flashing light, the AED requires service. (Refer to the “*Checking The DDU-2400/2450 AED Status*” section below for more details on the meaning of the indicator.)

**\*Note:** The battery pack must be removed from the unit for more than 10 seconds for the battery pack self-test to be performed automatically.

To remove the battery pack, push the battery pack eject release latch. After the battery pack is partially ejected, pull the battery pack out.

### 3.5 Checking The DDU-2400/2450 AED Status

#### Active Status Indicator (ASI)

Once a fully functional battery pack is installed in the DDU-2400/2450 AED, an LED indicator located to the right of the ON/OFF button actively indicates unit status. If the unit is ready for use, the Active Status Indicator (ASI) will flash green. Ready for use means that the DDU-2400/2450 has passed the most recent self-test (scheduled or user initiated). If the unit needs service, the ASI will flash red. Anytime the ASI flashes red, the unit will also “beep” periodically to call attention to itself. The ASI also uses a distinct flash pattern to assist people with color blindness: green will flash a single flash and red will flash a double flash.

The ASI is powered by the battery pack. If the battery pack has been completely discharged or is not installed in the unit, the active status indication will be off. In this case, immediately replace the battery pack or reinsert it into the unit to restore active status indication.

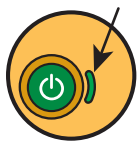

**Active Status Indicator (ASI)**

- **Flashing Green:** The DDU-2400/2450 AED is OFF and ready for use.
- **Solid Green:** The DDU-2400/2450 AED is ON and ready for use.
- **Flashing or Solid Red:** The DDU-2400/2450 AED needs immediate service. Refer to the “*Troubleshooting*” section in Chapter 7 of this manual or call Defibtech for service.
- **No Flashing Light:** The DDU-2400/2450 AED needs immediate service. Refer to the “*Troubleshooting*” section in Chapter 7 of this manual or call Defibtech for service.



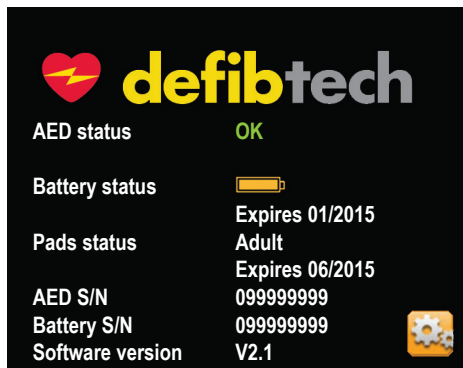

AED Status screen



To check the status of the AED when the unit is off, press the **center softkey button**. The display screen will show unit status, battery pack status, and pad status. After a short period of time, the display screen, and the unit will turn off.

### 3.6 Completing The Installation

Once you have completed the previous steps to set up your DDU-2400/2450 AED, follow this procedure:

1. Turn the unit on by pressing the ON/OFF button.
2. Listen for the "Call for Help" voice prompt.
3. Turn unit off by pressing and holding the ON/OFF button.
4. Listen for the "Powering Off" voice prompt.
5. Check Active Status Indicator (ASI) to verify that it is flashing green.

(Refer to the "Self-Tests" section in Chapter 7 of this manual for instructions on how to run a manually initiated self-test.)

### 3.7 Storing The DDU-2400/2450 AED

Store the DDU-2400/2450 AED, with defibrillation pads attached, in environmental conditions within range of the specifications. (Refer to the "Environmental" section in Chapter 11 of this manual.) The unit should also be stored so that the Active Status Indicator (ASI) can be readily seen.

The Active Status Indicator (ASI) should periodically flash with a green light. If it flashes with a red light or does not flash at all, the DDU-2400/2450 AED needs servicing. (Refer to the "Checking The DDU-2400/2450 AED Status" section in this chapter for more information.)

Defibtech recommends storing your AED in an easily accessible location.



## 4 Using The DDU-2400/2450 In AED Mode

This chapter describes how to use the DDU-2400/2450 in AED Mode. In AED Mode, the unit analyzes the patient's rhythm and automatically charges if a shockable rhythm is detected. The DDU-2400/2450 AED was designed for simple operation, allowing the operator to focus on the patient. There are two primary control buttons and a display screen. Concise and easily understandable voice messages and text and video prompts guide the operator through the use of the unit.

The following sections describe in detail how to use the DDU-2400/2450 AED. The basic steps for use are:

- Turn the DDU-2400/2450 AED ON by pressing the **ON/OFF** button.
- Plug in pads connector into Pad Connector Socket on AED if not yet plugged in.
- Place defibrillation pads on patient (**follow instructions on pads package**).
- Follow voice and display prompts.
- Press **SHOCK** button if instructed by the AED.
- Perform CPR when instructed.

### 4.1 Overview

**Pads Connector Socket** –  
Socket for pads connector

**ON/OFF Button** –  
Turns AED on and off

**Display Screen** –  
Displays video or ECG, text prompts and information

**Speaker** –  
Creates audio output from device

**Active Status Indicator (ASI)** –  
Indicates the current status of the AED

**Softkey Buttons**  
(Top, Center, Bottom) –  
Buttons used to navigate menus or select options

**SHOCK Button** –  
Enabled/disabled by software to allow the user to discharge a shock to the patient

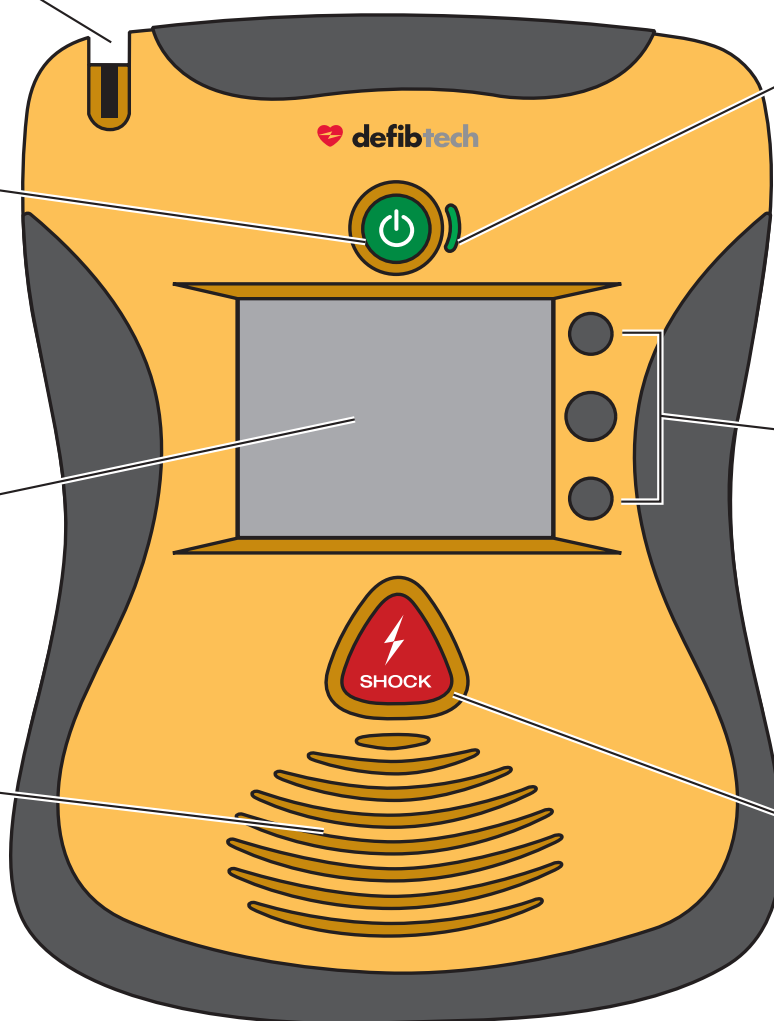

Overview (continued)

**Unit Video Display Screen** (During AED Mode)

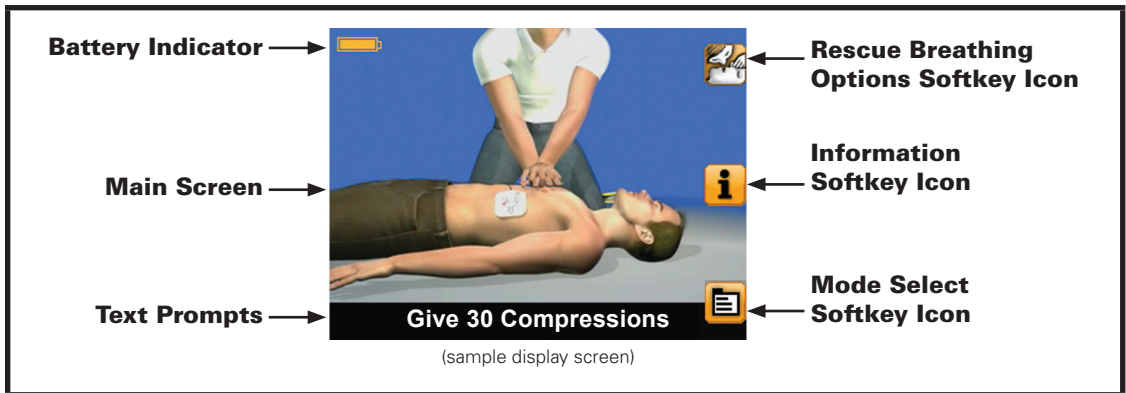

**Battery Indicator** – The Battery Indicator indicates the *approximate* remaining battery capacity.

**Main Screen** – The Main Screen displays video instructions to guide the user during a rescue.

**Text Prompts** – The Text Prompt Area displays text prompts to guide the user during a rescue.

**Softkey Buttons** (*not pictured*) – The Softkey Buttons are located to the right of the display screen. If a softkey button is active, it will have a softkey icon displayed next to it. The softkey buttons are used to navigate menus or select actions.

**Rescue Breathing Options Softkey Icon** – When this icon is present on the screen (during a rescue), the user may press the corresponding softkey button to select CPR coaching with compressions only (no breathing) or CPR coaching with compressions and breathing.

**Information Softkey Icon** – When this icon is present on the screen, the user may press the corresponding softkey button for additional information with video instruction. The additional information is context dependent; topics include preparing the patient and performing CPR. To exit, press the softkey button again.

**Mode Select Softkey Icon** – When this icon is present on the screen (during a rescue), the user may press the corresponding softkey button to bring up the Mode of Operation selection screen.

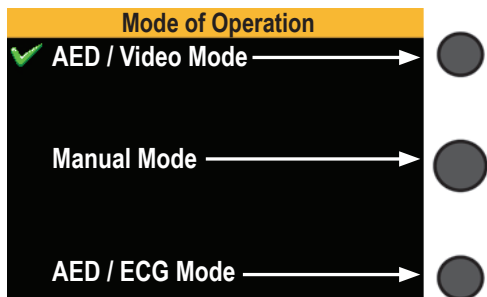

Mode of Operation screen  
(with corresponding softkeys)

The user may then select AED Mode with video, AED Mode with ECG, or Manual Mode (available only for DDU-2400 with Manual Mode enabled) by pressing the corresponding softkey button. If no selection is made within 8 seconds, the AED will continue in the current mode. The current mode is indicated with a green check mark next to it.

### Unit ECG Display Screen (During AED Mode)

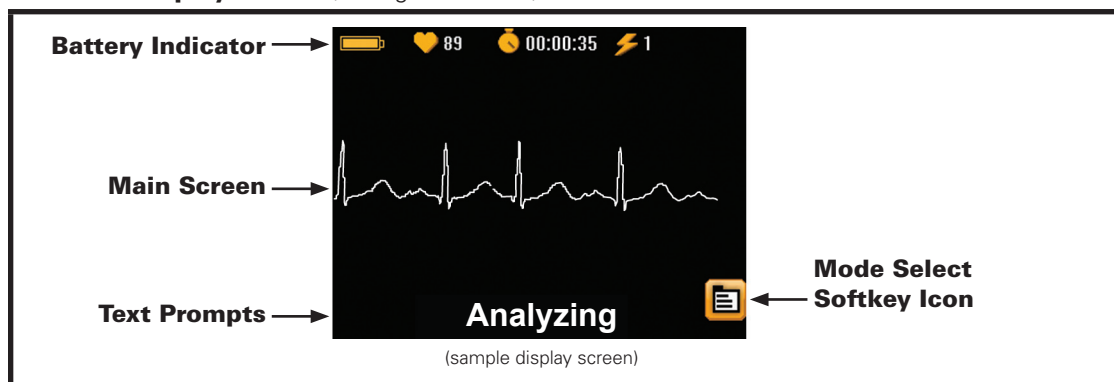

**Battery Indicator** – The Battery Indicator indicates the *approximate* remaining battery capacity.

**Heart Rate Indicator** – The Heart Rate Indicator displays the patient’s heart rate.

**Elapsed Time** – The Elapsed Time displays the time since the start of the event in hr:min:sec.

**Shock Count** – The Shock Count displays the number of shocks delivered for current event.

**Main Screen** – The Main Screen displays the patient’s ECG if the pads are connected.

**Text Prompts** – The Text Prompt Area displays text prompts to guide the user during a rescue.

**Mode Select Softkey Icon** – When this icon is present on the screen (during a rescue), the user may press the corresponding softkey button to bring up the Mode of Operation selection screen.

## 4.2 Preparation

### Checking The DDU-2400/2450 AED Status

Visually check the Active Status Indicator (ASI). The ASI should flash green. The ASI flashes green to indicate ready for use status. The ASI flashes red, solid red, or is not lit at all to indicate that service is required.

The ASI is powered by the battery pack. If the battery pack has been completely discharged or is not installed in the unit, the active status indication will not be available. In this case, immediately replace the battery pack or reinsert it into the unit to restore active status indication.

 <p><b>Active Status Indicator (ASI)</b></p>	<ul style="list-style-type: none"> <li>• <b>Flashing Green:</b> The DDU-2400/2450 AED is OFF and ready for use.</li> <li>• <b>Solid Green:</b> The DDU-2400/2450 AED is ON and ready for use.</li> <li>• <b>Flashing or Solid Red:</b> The DDU-2400/2450 AED needs immediate service. Refer to the “<i>Troubleshooting</i>” section in Chapter 7 of this manual or call Defibtech for service.</li> <li>• <b>No Flashing Light:</b> The DDU-2400/2450 AED needs immediate service. Refer to the “<i>Troubleshooting</i>” section in Chapter 7 of this manual or call Defibtech for service.</li> </ul>
---	--

### Turning On The DDU-2400/2450 AED

Press the green ON/OFF button to turn the DDU-2400/2450 AED on. The unit will emit a “beep” and the display screen will turn on. The ASI indicator next to the ON/OFF button will illuminate green anytime the AED is on. (To turn the unit off, press AND HOLD the ON/OFF button for approximately two seconds; the unit will emit a “beep” and power off.)

### Call For Help

Call professional emergency services for help. As soon as the AED is turned on the unit will prompt the user to “Call for help.” This is a reminder that the first step in a rescue should always be to contact professional emergency services.

If another person is available, the user should direct that person to call for help and then continue the rescue without delay.

## Selecting an Alternate Spoken Language

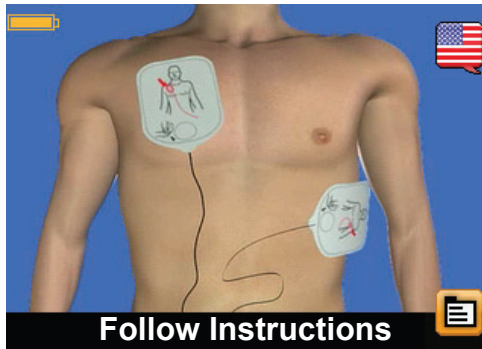

Some AED models are factory configured to support an alternate spoken language. If the AED supports an alternate language, a **Language Softkey Icon** (represented in the form of a flag) will be displayed. When the Language Softkey Icon is present, the user may press the corresponding softkey to switch the spoken voice prompts to the alternate language.

**(Note: Text prompts continue in the primary language.)**

Pressing the Language Softkey Icon again will switch the spoken language back to the primary language. The Language Softkey Icon is available only until the defibrillation pads are connected to the patient.

## Preparing The Patient

Prepare the patient by removing any clothing from the patient's chest. Wipe away moisture from the chest if necessary (the defibrillation pads will stick better on dry skin). If necessary, shave excessive chest hair, which can prevent effective patient-electrode contact. To ensure that defibrillation pads fully contact the patient's skin, check that no jewelry or other objects are directly underneath where the pads will be placed.

## Connecting Pads To The DDU-2400/2450 AED

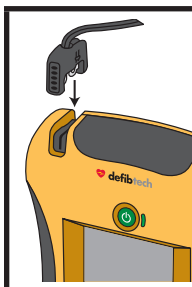

Connect pads to unit, if not already connected. Follow AED voice and display instructions. The DDU-2400/2450 AED is designed to be stored with the defibrillation pads connector attached to the unit, while the pads themselves remain sealed in their package. This reduces the time needed to setup and start treatment in an emergency.

The Defibtech AED should be stored with the pads connector attached to the unit. However, if pads were damaged or not properly connected, you may need to substitute a new set of pads during an emergency. The pads connector socket is on the top left corner of the AED.

To detach a set of pads from the unit, pull firmly on the pad connector. Do not reuse used pads. Insert the connector for the new pads as shown above. The connector will only fit in one way – if the connector does not fit, rotate the connector before trying again. Insert connector firmly until it is completely seated in the unit.



When this **Information Softkey Icon** is present on the screen, the user may press the corresponding softkey button for additional information with video instruction. To exit, press the softkey button again.

## Opening The Defibrillation Pads Package

Remove the pads package from the pad storage slot at the back of the AED. Open the pads package by tearing along the dotted line, starting at the black arrow (follow directions on the package). Check that the pads are:

- Free from obvious signs of damage.
- Clean of excessive debris (for example, dirt if the pad was dropped).
- Not dried out, and that the gel is sticky and will adhere to the patient.
- Not expired. Do not use pads after the expiration date printed on the package.

If any of these conditions are found, use a new set of pads, if possible.

## Applying Defibrillation Pads To The Patient

Apply pads correctly to patient. Follow AED voice and text prompts. Correct pad placement is essential for effective analysis of the patient's cardiac rhythm and subsequent shock delivery (if required).

Remove the pads from the pads package by tearing the package along the dotted line near the top of the package. Follow the directions and diagram showing proper defibrillation pad placement located on the defibrillation pads package and on the pads.

Peel off each pad from the blue liner before placing it as shown on the picture on the pad. Peel the pad off the blue liner only when the pad is ready to be placed on the patient.

Place the pads with the sticky side of the pad on the patient's skin. Pad placement on infants and children under 8 years or less than 55 pounds (25kgs) is different than placement for adults and children 8 years or older or over 55 pounds (25kgs). If you are unsure of a child's age or weight or do not have child/infant pads, do not delay treatment.

Place the pads on the patient's bare chest exactly as shown in the picture on the pad. See diagrams below:

Sample Adult Pads

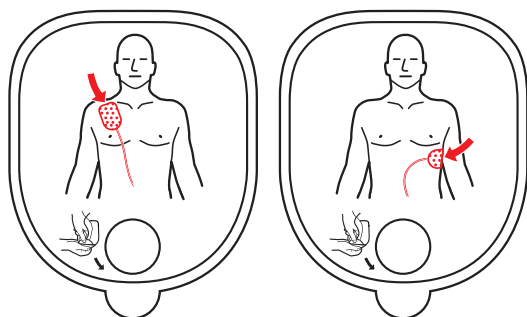

Sample Child/Infant Pads

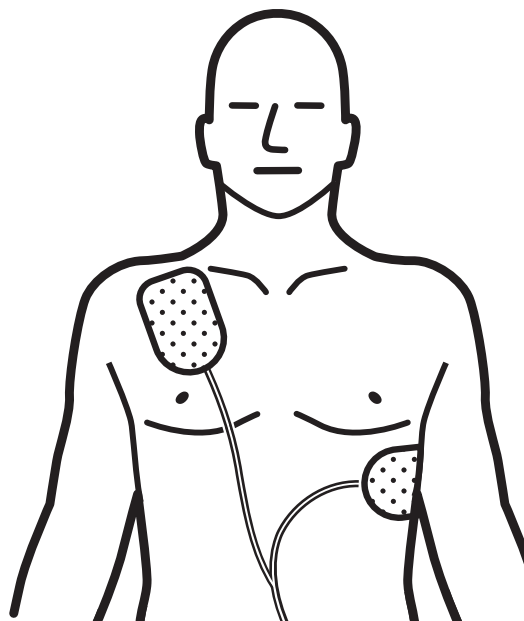
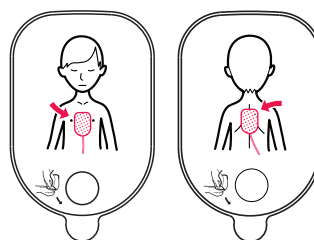

**For adults and children 8 years or older or over 55 pounds (25kgs), use adult pads:**

Place one pad just below the patient's right collar bone as shown in the picture. Place the second pad over the ribs on the patient's left side below the left breast.

Use picture on pad to determine individual pad placement.

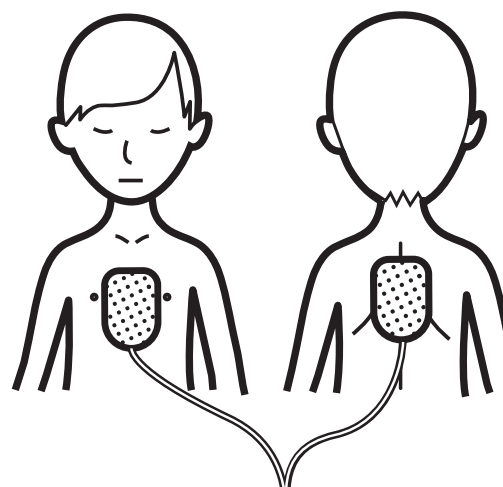

**For infants and children under 8 years or less than 55 pounds (25kgs), use child/infant pads**  
**(Note: Child/infant pads can be identified by their blue connector and pads package):**

Place one pad in the center of the chest and one pad on the center of the back, as shown. Use picture on pad to determine individual pad placement.

### Follow DDU-2400/2450 AED Instructions

At this point, the DDU-2400/2450 AED will check to make sure that the pads are well connected to the patient and that an adequate ECG signal is being received. Do not touch the patient. Eliminate any patient movement, and cease CPR at this time.

If there is a problem with the pad connection, socket connection, patient motion, or other interference, the AED will guide the operator with both audible and displayed instructions. Text prompts are identical to or are an abbreviated form of the audio prompts. Video prompts reinforce the audio and text prompts and aid in high ambient noise environments.

### 4.3 Heart Rhythm Analysis

Once the DDU-2400/2450 AED has determined that the pads are making a good connection to the patient, the AED will start the ECG rhythm analysis. The unit analyzes the ECG signal and determines whether a shockable or non-shockable rhythm is present. While analyzing, the AED will continue to monitor signal and pad conditions and will reassess analysis and prompt the user if additional user action is needed.

### 4.4 Delivering The Shock

If the DDU-2400/2450 AED ECG analysis algorithm has determined that a shock is required, the unit will automatically charge in preparation for shock delivery. While the AED charges, the unit may emit a charging tone and will continue to analyze the patient's heart rhythm. If the unit detects that the heart rhythm has changed to one that does not require a shock, the unit will prompt the user to begin CPR. While analyzing, the AED will continue to monitor signal and pad conditions.

If the unit has determined that a shock is required and has completed charging, the SHOCK button will flash and the user will be instructed to press the flashing SHOCK button. The user should follow the AED instructions and press the SHOCK button.

**Important:** The DDU-2400/2450 AED will not automatically deliver a shock — the user must press the flashing SHOCK button. If while waiting for the SHOCK button to be pressed, the unit detects a rhythm change to a non-shockable rhythm, the unit will cancel the shock. Also, if the SHOCK button is not pressed within 30 seconds of the initial "press flashing SHOCK button" prompt, the unit will automatically cancel the shock.

The user can abort charging or shock delivery at any time by pressing and holding the ON/OFF button for approximately two seconds to turn the unit off.

### 4.5 CPR Period

The operator will be prompted to begin CPR. The unit will not monitor the patient's ECG rhythm during the CPR period. During the CPR period, the AED will not advise the user to "stop motion" even if motion is present.

The user should follow the AED instructions during this time. Once the CPR period is complete, the unit will continue in Heart Rhythm Analysis mode.

CPR coaching is provided through a series of voice and visual prompts and audible tones. The factory default setting provides prompts for chest compressions only (no breathing).

However, breathing prompts can be enabled/disabled by pressing the softkey button next to the Rescue Breathing Options icon displayed on the screen during rescue. (Refer to the "Rescue Breathing Options Softkey Icon" section below.) Breathing prompts can also be enabled/disabled by setting the menu option in Maintenance Mode. (Refer to the "*CPR Breathing*" section in Chapter 8 of this manual.)



**Rescue Breathing Options Softkey Icon:** During a rescue, when this icon is present on the screen, the user may press the corresponding softkey button to select CPR coaching with compressions only (no breathing) or CPR coaching with compressions and breathing.

**Note:** Refer to the "*CPR Breathing*" section in Chapter 8 of this manual for instructions on how to change the factory default setting.



When this **Information Softkey Icon** is present on the screen, the user may press the corresponding softkey button for additional information with video instruction. To exit, press the softkey button again.

## 4.6 Post Use Procedures

After the DDU-2400/2450 AED has been used on a patient, the unit should be cleaned following procedures in the “*Cleaning*” section in Chapter 7 of this manual and prepared for the next use. The following steps should be performed:

1. Connect a new pads package (check to make sure the package is not expired and package is not damaged).
2. Perform a self-test manually. Unit will report status at the end of the self-test. (Refer to the “*Self-Tests*” section in Chapter 7 of this manual for instructions on how to run a manually initiated self-test.)
3. Turn off the unit by pressing the ON/OFF button.
4. Check to make sure that the Active Status Indicator (ASI) is flashing green.

## 4.7 AED Mode Voice And Text Prompts

The following section provides brief descriptions of some of the voice and text prompts that the user will hear and see in AED Mode.

### General Prompts

<b>Voice</b>	<b>Text</b>
<b>“Call for help”</b>	<b>Call For Help</b>
<i>Purpose:</i> As soon as the DDU-2400/2450 AED is turned on, the user will be prompted to call for help. This indicates that the first step in a rescue should always be to contact professional emergency services. If another person is available, the user should direct that person to call for help and then continue the rescue without delay.	
<b>“Pediatric mode”</b>	<b>Pediatric Mode</b>
<i>Purpose:</i> This informs the user that child/infant pads are attached to the unit. Child/infant pads should only be used if the patient is an infant or a child under the age of 8 or less than 55 pounds (25kgs). For children 8 years or older or over 55 pounds (25kgs) and for adults, adult pads should be used. Do not delay therapy to determine exact age or weight.	
<b>“Training pads”</b>	<b>Training Pads</b>
<i>Purpose:</i> This informs the user that training pads are attached to the unit. Training pads are used for training purposes only and will not deliver a shock. In a rescue, immediately replace the training pads with defibrillation pads.	
<b>“Powering off”</b>	<b>Powering Off</b>
<i>Purpose:</i> This informs the user that the unit is turning off.	

### Pad Connection/Pad Application Related Prompts

<b>Voice</b>	<b>Text</b>
<b>“Follow instructions to apply pads”</b>	<b>Follow Instructions</b>
<i>Purpose:</i> This instructs the user to follow the AED prompts in order to apply the pads to the patient.	
<b>“Remove clothing from patient’s chest”</b>	<b>Remove Clothing</b>
<i>Purpose:</i> This instructs the user to remove all clothing from patient’s chest. Pads must be applied to the patient’s bare chest.	
<b>“Locate pads package in back of AED”</b>	<b>Locate Pads</b>
<i>Purpose:</i> This helps the user locate the pads in the pad storage area, which is located on the back of the unit.	
<b>“Plug in pads connector”</b>	<b>Plug In Pads</b>
<i>Purpose:</i> The DDU-2400/2450 AED is unable to detect that the pads are plugged in. Check that the connector is fully inserted into the unit. If the pads are properly plugged in, continue to follow audio and visual instructions.	
<b>“Tear open pads package”</b>	<b>Open Pads Package</b>
<i>Purpose:</i> This instructs the user to tear open the pads package on the dotted line on the top of the package. Once the package is open, the user will be able to remove the pads from inside the package.	



*Pad Connection/ Pad Application Related Prompts (continued)*

<b>Voice</b>	<b>Text</b>
<b>"Peel pads from blue liner"</b>	<b>Peel Pads</b>
<i>Purpose:</i> This instructs the user to peel each pad from the blue liner before placing the pads on the patient. Peel the pads from the blue liner only when the pad is ready to be placed. Place the pads with the sticky side of the pad on the patient's bare skin.	
<b>"Apply pads to patient's bare chest as shown"</b>	<b>Apply Pads to Patient</b>
<i>Purpose:</i> The DDU-2400/2450 AED has determined that the pads are not placed on the patient or not properly applied. Place pads on the patient following instructions on the pads package. If the prompts continue, try replacing the pads with a new set.	
<b>"Poor pad contact to patient" "Press pads firmly"</b>	<b>Poor Pad Contact Press Pads Firmly</b>
<i>Purpose:</i> The pads are not making proper contact with the patient and the impedance is out of range for proper ECG analysis and shock delivery. Check that the pads are properly placed and fully adhering to the patient and that there are no air bubbles between the pads and the patient. If the pads are not sticking due to moisture, dry the patient. If the pads are not sticking due to excessive hair, shave or clip excessive chest hair. If the prompts continue, try replacing the pads with a new set.	
<b>"Check pads"</b>	<b>Check Pads</b>
<i>Purpose:</i> The pads are making improper contact with the patient or touching each other and the impedance is out of range for proper ECG analysis and shock delivery. Check that the pads are not touching each other and that the patient is dry. If the prompts continue, try replacing the pads with a new set.	
<b>"Pausing for CPR"</b>	<b>Pausing for CPR</b>
<i>Purpose:</i> If too long a period of time has passed, the user should stop attempting to resolve problems with the pads and assess the condition of the patient. The user will be prompted to begin CPR.	
<b>"Replace pads"</b>	<b>Replace Pads</b>
<i>Purpose:</i> The pads are making improper contact with the patient or touching each other and the impedance is out of range for proper ECG analysis and shock delivery. If another set of pads is available, replace the pads, otherwise check that the pads are properly placed and fully adhering to the patient. Make sure that the pads are not touching each other. If the pads are not sticking due to moisture, dry the patient. If the pads are not sticking due to excessive hair, shave or clip excessive chest hair. If the prompts continue, try replacing the pads with a new set.	

**Motion/Interference Prompts**

<b>Voice</b>	<b>Text</b>
<b>"Stop motion"</b>	<b>Stop Motion</b>
<i>Purpose:</i> The DDU-2400/2450 AED has detected possible motion in the patient. Stop all patient motion, including CPR, in response to this prompt.	
<b>"Stop interference"</b>	<b>Stop Interference</b>
<i>Purpose:</i> The DDU-2400/2450 AED has detected interference on the ECG signal. Eliminate any radio or electrical sources of interference. Check the pads to make sure they are adhering properly to the patient. If the environment is very dry, minimize movement around the patient to reduce static discharges.	
<b>"Pausing for CPR"</b>	<b>Pausing for CPR</b>
<i>Purpose:</i> The user should stop attempting to resolve motion and/or interference problems and assess the condition of the patient. The user will be prompted to begin CPR.	



## Heart Rhythm Analysis Prompts

<b>Voice</b>	<b>Text</b>
<b>"Analyzing heart rhythm"</b> <b>"Analyzing"</b>	<b>Analyzing Rhythm</b> <b>Analyzing</b>
<i>Purpose:</i> The DDU-2400/2450 AED is actively analyzing the patient's ECG signal. The AED will continue analyzing until it has determined whether a rhythm is shockable or non-shockable or if analyzing is interrupted for some reason.	
<b>"Do not touch the patient"</b>	<b>Do Not Touch Patient</b>
<i>Purpose:</i> The DDU-2400/2450 AED is trying to analyze the patient's heart rhythm. The operator should not touch the patient. This prompt will be spoken at the beginning of the analysis period and also if motion or interference has been detected.	
<b>"Analyzing interrupted"</b>	<b>Analyzing Interrupted</b>
<i>Purpose:</i> The DDU-2400/2450 AED has determined that accurate ECG analysis is not possible and has ceased analyzing. The operator is prompted to resolve the problem. (Refer to the " <i>Motion/Interference Prompts</i> " and the " <i>Pad Connection/Pad Application Related Prompts</i> " section in this chapter.) Once the problem is resolved, the unit will enter analysis mode again.	
<b>"No shock advised"</b>	<b>No Shock Advised</b>
<i>Purpose:</i> The DDU-2400/2450 AED has determined that a shock is not required. The unit will <b>NOT</b> charge and the SHOCK button will <b>NOT</b> be enabled. The user will be prompted to begin CPR.	
<b>"Shock advised"</b>	<b>Shock Advised</b>
<i>Purpose:</i> The DDU-2400/2450 AED has determined that a shock is recommended and the unit will begin charging in anticipation of delivering a defibrillation shock.	

## Shock Related Prompts

<b>Voice</b>	<b>Text</b>
<b>"Charging"</b>	<b>Charging</b>
<i>Purpose:</i> The DDU-2400/2450 AED has determined that a shock is recommended and is charging the unit in anticipation of a defibrillation shock. Analysis will continue during this phase. A tone will sound to indicate charging progress. If the unit detects a rhythm change to a non-shockable one, charging will abort and the user will be prompted to begin CPR.	
<b>"Stand clear"</b>	<b>Stand Clear</b>
<i>Purpose:</i> The DDU-2400/2450 AED is charging and the operator and others should stand clear of the patient. Analysis will continue during this phase and analyzing prompts will continue to be displayed. A tone will sound to indicate charging progress. If the unit detects a rhythm change to a non-shockable one, charging will abort and the user will be prompted to begin CPR.	
<b>"Press flashing SHOCK button"</b>	<b>Press SHOCK Button</b>
<i>Purpose:</i> The DDU-2400/2450 AED has fully charged, the heart rhythm analysis algorithm still indicates that a shock is recommended, and the unit is ready to deliver a shock. The operator should press the SHOCK button to deliver the shock. The SHOCK button will flash during this phase and will cancel after 30 seconds. <b>Important:</b> The DDU-2400/2450 AED will not automatically deliver a shock – the user must press the SHOCK button.	
<b>"Shock 'x' delivered"</b>	<b>Shock "x" Delivered</b>
<i>Purpose:</i> The DDU-2400/2450 AED has delivered the shock. The 'x' indicates the number of shocks that have been delivered since the unit was turned on. After each shock, the AED will enter Post-Shock CPR mode. (AHA/ERC 2010 Protocol)	
<b>"Shock cancelled"</b>	<b>Shock Cancelled</b>
<i>Purpose:</i> The DDU-2400/2450 AED has aborted shock mode. If while waiting for the SHOCK button to be pressed, the unit detects a rhythm change to a non-shockable rhythm, the unit will cancel the shock. Also, if the SHOCK button is not pressed within 30 seconds of the initial "press flashing SHOCK button" prompt, the unit will automatically cancel the shock.	

Shock Related Prompts (continued)

Voice	Text
<b>"SHOCK button not pressed"</b>	<b>Button Not Pressed</b>
<i>Purpose:</i> After shock is advised, the DDU-2400/2450 AED will prompt user to press the flashing shock button. If after 30 seconds the shock button is not pressed, the DDU-2400/2450 AED will give this prompt and immediately go to CPR mode.	

**No Shock Required Prompts**

Voice	Text
<b>"No shock advised"</b> <b>"It is safe to touch the patient"</b>	<b>No Shock Advised</b> <b>OK to Touch Patient</b>
<i>Purpose:</i> The DDU-2400/2450 AED has determined that a shock is not required. The unit will not charge and the SHOCK button will not be enabled. The user will be prompted to begin CPR.	

**CPR Prompts**

**Note:** CPR breathing coaching prompts can be set through the **Rescue options** menu option listed on the **AED Main Menu** screen. The factory default setting provides prompts for chest compressions only (no breathing). Breathing prompts can be included either by changing the menu option (refer to the *"CPR Breathing"* section in Chapter 8 of this manual) or by pressing a softkey button during rescue. (Refer to *"Rescue Breathing Options Softkey Icon"* section of this chapter.)

Voice	Text
<b>"Begin CPR now"</b>	<b>Begin CPR Now</b>
<i>Purpose:</i> This indicates that the user should begin performing CPR immediately. The unit will not monitor the patient's ECG rhythm during this CPR period.	
<b>"Give Compressions"</b>	<b>Give "xx" Compressions</b>
<i>Purpose:</i> This indicates that the user should begin CPR compressions immediately. The unit will emit a beep at the rate that compressions should be given.	
<b>"Continue"</b> <b>"Continue for 1 minute 'xx' seconds"</b>	<b>Continue "xx" Seconds</b>
<i>Purpose:</i> This indicates that the user should continue performing CPR. This phrase is spoken to let the user know that the unit is still operating normally. The unit will not be monitoring the patient's ECG rhythm during this mandatory two minute CPR period. (AHA/ERC 2010 Protocol)	
<b>"Ending in 5, 4, 3, 2, 1"</b>	<b>Ending in "xx" Seconds</b>
<i>Purpose:</i> This indicates that the user should prepare to finish performing CPR. This phrase is spoken during the last several seconds of the CPR period to let the operator know that the unit is still operating normally and that the CPR period is ending.	
<b>"Stop CPR"</b> <b>"Stop Now"</b>	<b>Stop CPR</b> <b>Stop Now</b>
<i>Purpose:</i> This indicates that the CPR period has ended and the user should stop CPR. The unit will enter Analyze Mode.	
<b>"Do not touch the patient"</b> <b>"Analyzing heart rhythm"</b>	<b>Do Not Touch Patient</b> <b>Analyzing Rhythm</b>
<i>Purpose:</i> This indicates the unit has entered Analyze Mode and is performing an ECG analysis. The user should not touch the patient during the ECG analysis.	

### CPR Coaching Help Prompts

<b>Voice</b>	<b>Text</b>
<b>"Place hands"</b>	<b>Place Hands</b>
<i>Purpose:</i> This reminds the user of the correct placement of hands for CPR.	
<b>"Press"</b> <b>"Compress Chest"</b>	<b>Press</b> <b>Compress Chest</b>
<i>Purpose:</i> This reminds the user to perform CPR compressions.	
<b>"Tilt head back"</b> <b>"Pinch nose"</b> <b>"Give rescue breaths"</b>	<b>Tilt Head Back</b> <b>Pinch Nose</b> <b>Give "x" Breaths</b>
<i>Purpose:</i> This guides the user to prepare the patient for rescue breaths and to give breaths.	
<b>"Breathe"</b>	<b>Breathe</b>
<i>Purpose:</i> This instructs the user to give rescue breaths. Each time the instruction is given, the user should give the patient a rescue breath.	

## 4.8 Operational Environment

The Defibtech AED is designed to operate in a wide range of environmental conditions. To ensure the reliability and safety of the AED in a given environment, refer to the "*Environmental*" section in Chapter 11 of this manual for a detailed list of approved environmental conditions.

# 5 Manual Mode (DDU-2400 only)

The DDU-2400 AED provides a Manual Mode to override the AED features of the defibrillator. Manual Mode provides an ECG display of patient's rhythm as well as operator-initiated charge, shock, and disarm functions. Manual Mode should only be used by qualified medical personnel trained in advanced life support skills and ECG recognition who want to deliver a shock independent of AED Mode.



The DDU-2400 Manual Mode Charge feature is intended for use only by authorized operators who have been specifically trained in cardiac rhythm recognition and in manual defibrillation therapy.

## 5.1 Entering Manual Mode



When the **Mode Select Icon** is present on the screen, the user may press the corresponding softkey button to bring up the Mode of Operation screen.

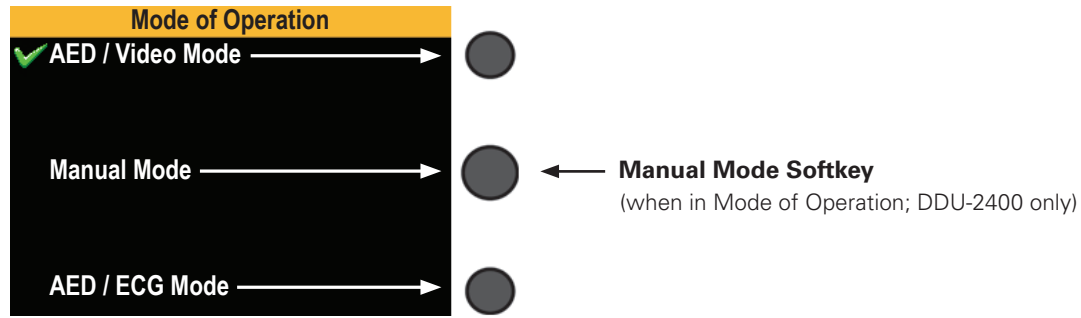

Mode of Operation screen

When Manual Mode is entered, the main screen automatically switches to ECG view and text prompts provide instruction. **(NOTE: Voice prompts are disabled while in Manual Mode.)** If the pads are not applied, the display will show a dashed ECG and prompt the user to apply the pads. When the pads are applied, the display shows the patient's ECG and heart rate.

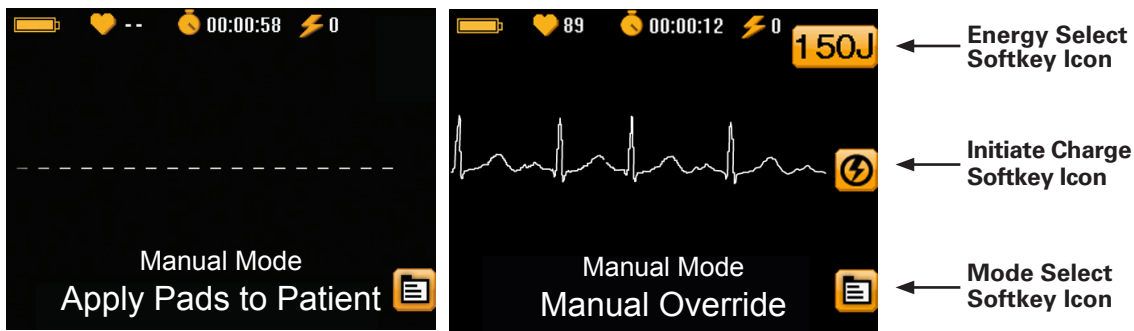

Manual Mode: unapplied pads

Manual Mode: pads applied

## 5.2 Exiting Manual Mode



To exit Manual Mode, press the softkey associated with the **Mode Select Icon** and select a mode of operation.

### 5.3 Selecting Energy

	<p>The user may select the desired energy level by pressing the softkey associated with the <b>Energy Select Icon</b> (upper button). The default energy when entering Manual Mode is always 150 J (adult pads) or 50 J (pediatric pads). Pressing the Energy Select Icon will cycle the energy through the following options:</p> <ul style="list-style-type: none"> <li>• 25, 50, 70, 100, 150, 200 Joules (Adult pads attached)</li> <li>• 25, 50, 70, 100 Joules (Pediatric non-attenuating pads attached)</li> <li>• 50 Joules (not selectable) (Pediatric attenuating pads attached)</li> </ul>
---	---

### 5.4 Initiating Charge

	<p>To initiate charging, press the softkey associated with the <b>CHARGE Softkey Icon</b> (middle button). The AED's main screen will display a progress bar and produce an audible rising tone while charging. The CHARGE Softkey Icon will change to the DISARM Softkey Icon.</p>
---	---



Charging Screen

← DISARM Softkey Icon

	<p>While charging, pressing the softkey associated with the <b>DISARM Softkey Icon</b> (middle button) will cancel the charge.</p>
---	--

### 5.5 Delivering The Shock

When charging is complete, the AED will prompt the user to press the flashing SHOCK button and will produce a two-toned audible alarm.



Shock Delivery Screen

The user should follow the AED's onscreen text instructions and press the flashing SHOCK button. (**Note:** If the SHOCK button is not pressed within 30 seconds, the AED will automatically disarm.)

**IMPORTANT: The DDU-2400/2450 AED will not automatically deliver a shock – the user must press the flashing SHOCK button.**

The user can abort charging or shock delivery at any time while in Manual Mode by pressing the DISARM softkey (middle button) or by pressing and holding down the AED's ON/OFF button for approximately two seconds to turn the unit off.

	<p>← SHOCK button (flashes when ready to shock)</p>
---	---

## 6 ECG Monitor Mode

At the discretion of emergency care personnel, the DDU-2400/2450 AED can also be used with an optional ECG Monitoring Adaptor (DAC-2020/2021) to provide a non-diagnostic ECG display of the patient's heart rhythm for attended patient monitoring. The system is intended for use on a conscious or breathing patient, regardless of age. While connected to the ECG Monitoring Adaptor, the DDU-2400/2450 AED's shock capability is disabled, but it continues to evaluate the patient's ECG. There are no known contraindications to use of the ECG Monitoring Adaptor.

**Note:** The AED does not have to be turned off before changing from defibrillation pads to the ECG Monitoring Adaptor or vice versa. To deliver a shock to the patient, disconnect the ECG Monitoring Adaptor and attach the defibrillation pads.

### 6.1 Entering ECG Monitor Mode

Remove the defibrillation pads and plug in the optional ECG Monitoring Adaptor. The AED will automatically switch to ECG Monitor Mode with ECG view and onscreen text prompts will provide instruction. **(NOTE: Voice prompts are disabled while in ECG Monitor Mode.)** If the pads are not applied, the display will show a dashed ECG and prompt the user to apply the pads. When the pads are applied, the display shows the patient's ECG and heart rate.

**Note:** The ECG Monitoring Adaptor uses the same connector socket in the AED used by the defibrillation pads.

### 6.2 Applying The ECG Monitoring Electrodes

Apply ECG monitoring electrodes to the patient's chest as shown below:

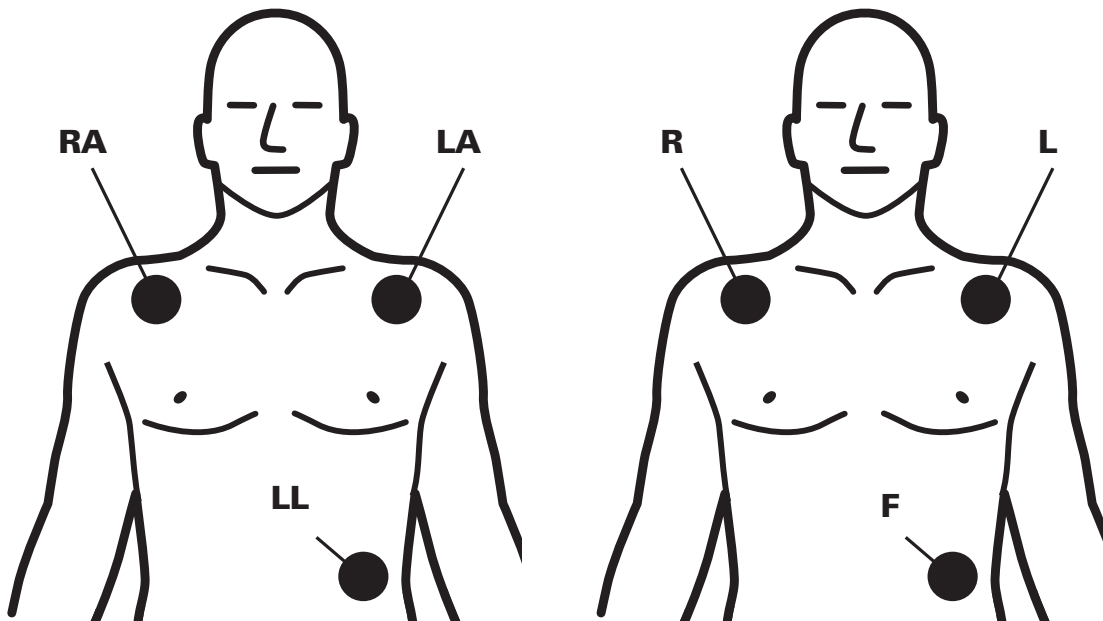

**AHA LABELS:** (DAC-2020)

**RA** – Right Arm  
**LA** – Left Arm  
**LL** – Left Leg

**IEC LABELS:** (DAC-2021)

**R** - Right  
**L** - Left  
**F** - Foot

## 6.3 Monitoring The Patient

After the ECG monitoring electrodes are connected, the defibrillator displays a non-diagnostic ECG of the patient's heart rhythm and heart rate in a Lead II configuration. While in ECG Monitor Mode, the defibrillator's shock capability is disabled; however, the defibrillator continues to evaluate the patient's ECG for a potentially shockable rhythm.

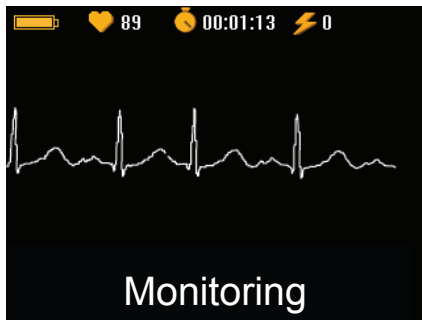

*ECG Monitor Mode Screen*



*Shockable rhythm detected*

If a shockable rhythm is detected, the defibrillator prompts **Plug in Rescue Pads**.

- Confirm the patient's condition: Not responsive? Not breathing? No signs of circulation?
- Remove the ECG Monitoring Adaptor and connect the defibrillation pads (Rescue Pads) to the AED.
- Apply the defibrillation pads to the patient's chest, keeping them at least 2.5 cm (one inch) away from the ECG monitoring electrodes. If necessary, remove the ECG monitoring electrodes.
- Follow the AED's voice and onscreen text prompts.

# 7 Maintenance And Troubleshooting

This chapter describes the maintenance and troubleshooting procedures for the DDU-2400/2450 AED. The self-tests that are performed by the device are described along with the frequency and nature of routine maintenance for which the owner/operator is responsible. A troubleshooting guide is provided to help diagnose user serviceable problems.

The DDU-2400/2450 AED contains no user serviceable parts.

## 7.1 Routine Unit Maintenance

Although the DDU-2400/2450 AED is designed to be very low maintenance, simple maintenance tasks must be performed by the owner/operator on a regular basis to ensure the unit's dependability.

Daily	Monthly	After Each Use	Action
•		•	Check that the Active Status Indicator (ASI) is flashing green
	•	•	Check the condition of the unit and accessories
		•	Run manually initiated self-test
		•	Replace pads
	•		Check pad and battery pack expiration dates
		•	Check the DDC card, if one was installed

**Note:** If the unit has been dropped, mishandled, or abused, a manually initiated self-test should be performed.

### Checking The Active Status Indicator

The Active Status Indicator (ASI) is located to the right of the ON/OFF button of the DDU-2400/2450 AED and indicates the operational readiness state of the unit. The ASI will periodically flash green to indicate that the unit is ready for use. Ready for use means that the DDU-2400/2450 has passed the most recent self test (scheduled or user initiated). If it is flashing red, solid red, or not flashing at all, the AED needs service. Anytime the ASI is flashing red, the unit will periodically emit two "beeps" to call attention to it.

If the ASI is not flashing at all, the most likely cause is that the battery pack needs to be replaced. (Refer to the "Installing And Removing The Battery Pack" section in Chapter 3 of this manual.) Once the battery pack has been replaced with a fresh battery pack, the ASI should once again flash green. If it still does not flash green after inserting a new battery pack, the DDU-2400/2450 AED is non-operational and may need servicing. Call Defibtech for service. (Refer to the "Contacts" section in Chapter 14 of this manual.)

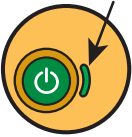

If the ASI is flashing red, turn the DDU-2400/2450 AED on. If the unit does not turn on or does not speak, the AED is non-operational and requires servicing. If the unit does turn on, then turn the unit off and the voice prompts will indicate the nature of the problem.

 <p><b>Active Status Indicator (ASI)</b></p>	<ul style="list-style-type: none"> <li>• <b>Flashing Green:</b> The DDU-2400/2450 AED is OFF and ready for use.</li> <li>• <b>Solid Green:</b> The DDU-2400/2450 AED is ON and ready for use.</li> <li>• <b>Flashing or Solid Red:</b> The DDU-2400/2450 AED needs immediate service. Refer to the "Troubleshooting" section in this chapter or call Defibtech for service.</li> <li>• <b>No Flashing Light:</b> The DDU-2400/2450 AED needs immediate service. Refer to the "Troubleshooting" section in this chapter or call Defibtech for service.</li> </ul>
---	--



## Checking The AED Status Using The AED Status Screen

You may also check the status of the unit when it is off by pressing the center softkey button to enter Maintenance Mode and display the AED Status Screen.

 <p><b>AED status</b>      <span style="color: green;">OK</span></p> <p><b>Battery status</b>       Expires 01/2015</p> <p><b>Pads status</b>      <b>Adult</b> Expires 06/2015</p> <p><b>AED S/N</b>      099999999</p> <p><b>Battery S/N</b>      099999999</p> <p><b>Software version</b>      V2.1 </p>	<p>The AED Status Screen is used to provide a quick overview of the DDU-2400/2450 AED's status and to display select information without turning the unit on in Rescue Mode.</p> <p>With the AED off, press and release the <b>CENTER</b> softkey button to display the AED Status Screen. The AED Status Screen will be displayed for a short period of time.</p> <p>If the unit does not turn on, check to make sure a good battery pack is installed. (Refer to the "<i>Troubleshooting</i>" section in this chapter.)</p> <p>From the AED Status Screen you can enter Maintenance Mode by pressing the softkey button to the right of the tool icon.</p>
--	--

**Note:** If the unit requires service, the AED Status Screen will present information about the problem to the user. The user should follow the text prompts to address the condition requiring attention.

	<p><b>Card Application Softkey Icon:</b> If an application is present on an inserted Defibtech Data Card (DDC card), a card icon will also appear next to the center softkey button. Pressing this button will load and run the application contained on the card.</p>
---	--

## Maintenance Related Prompts

Voice	Text
<b>"Power-on test failed"</b> <b>"Service code 'xxxx' "</b>	<b>Power On Test Failed</b> <b>Service Code "xxxx"</b>
<i>Purpose:</i> This indicates that the DDU-2400/2450 AED has failed the power-on self-test and is non-operational and needs servicing. The code number will indicate to service personnel the type of problem the unit is experiencing.	
<b>"Battery test failed"</b> <b>"Service code 'xxxx' "</b>	<b>Battery Test Failed</b> <b>Service Code "xxxx"</b>
<i>Purpose:</i> This indicates that the DDU-2400/2450 AED's battery pack is non-operational and needs servicing. The code number will indicate to the service personnel the type of problem that the unit is experiencing.	
<b>"Service code 'xxxx' "</b>	<b>Service Code "xxxx"</b>
<i>Purpose:</i> The DDU-2400/2450 AED will report this message when it powers off, indicating a service code that was previously detected.	
<b>"Service required"</b>	<b>Service Required</b>
<i>Purpose:</i> This indicates that the DDU-2400/2450 AED has detected an internal error, is non-operational, and needs servicing.	
<b>"Battery low"</b>	<b>Battery Low</b>
<i>Purpose:</i> This indicates that the battery pack capacity is low and that the battery pack should be replaced soon. The AED will still be able to deliver at least six defibrillation shocks the first time this message is spoken.	
<b>"Replace battery now"</b>	<b>Replace Battery Now</b>
<i>Purpose:</i> This indicates that the battery pack is almost discharged and that the AED may not be able to deliver defibrillation shocks. Replace the battery pack immediately.	
<b>"Pads missing"</b>	<b>Pads Missing</b>
<i>Purpose:</i> This indicates that the unit did not detect connected pads during a self-test.	
<b>"Pads expired"</b>	<b>Pads Expired</b>
<i>Purpose:</i> This indicates that defibrillation pads have expired. Replace the pads immediately.	

## Checking The Condition Of The Unit And Accessories

Inspect the unit for dirt and contamination, especially in the pads connector socket and around the battery pack opening. (Refer to the “*Cleaning*” section in this chapter of this manual for guidance on cleaning your AED.)

Inspect the unit display screen for damage. Look for cracks or other signs of damage on the case, especially near the connector socket.

If any cracks or other signs of damage are visible, remove the AED from service and contact an authorized service center.

## Replacing Pads

The Defibtech defibrillation pads are intended for one time use only. The pads must be replaced after each use or if the package has been damaged.

The DDU-2400/2450 AED defibrillation pads are supplied in a sealed pouch with the connector and part of the cable exposed. The DDU-2400/2450 AED is designed to be stored with the electrode cable already installed. This allows the pads to be stored in a pre-connected state for rapid deployment during an emergency.



**DO NOT** remove the defibrillation pads from the sealed package until the pads are to be used. The packaging should be opened only immediately prior to use, otherwise the pads may dry out and become non-functional.

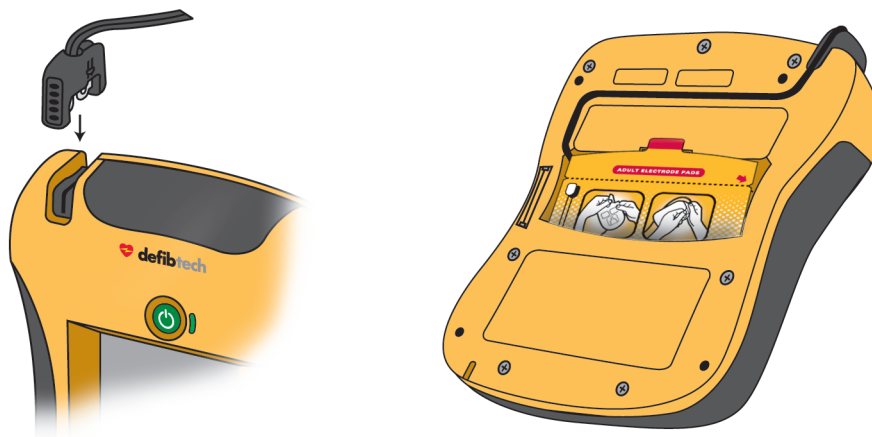

**STEP 1: Inspect The Pads** – First, check to ensure that the pads package has not expired. Do not use pads past their expiration date. Discard expired pads. Next, check to ensure that the pads package has not been torn, opened, or damaged. Dispose of the pads if the package is open or damaged. Inspect the pads cable and replace pads if any nicks, cuts, or broken cables are found.

**STEP 2: Connect The Pads To The Unit** – Insert the connector end of the defibrillation pad cable into the pads connector socket on the top-left corner of the DDU-2400/2450 AED as shown. Press the pads connector in firmly until it is fully seated in the unit.

**STEP 3: Store The Pads In Back Of Unit** – The pads package can then be stored in the pad storage slot in the back of the DDU-2400/2450 AED. After connecting the pads connector to the unit, push the pads package, rounded end first, with the pictures on the package facing up and out, into the pad holder compartment on the back of the AED. When the pads package is fully inserted, press the pad cable into the groove in the back of the unit to hold it in place and tuck any excess cable behind the pads package.



The defibrillation pads are intended for one-time use only and must be discarded after use or if the package has been opened.

### Checking Pad And Battery Pack Expiration Dates

It is important to check the expiration dates of the pads and battery pack. The expiration date of the pads package is printed on the outside of the sealed package. The expiration date of the battery pack is printed on the label on the battery pack. Once an accessory is past its expiration date, it should be taken out of service and replaced as soon as possible. Follow the instructions in the “*Installing And Removing The Battery Pack*” and “*Connecting The Pads*” sections of Chapter 3 in this manual to replace an expired part with an unexpired part. Pads should be discarded. Battery packs should be appropriately recycled.

You may also check the status of pads and battery pack when the unit is off by pressing the center softkey button to display the AED Status Screen and enter Maintenance Mode. (Refer to the “*AED Status Screen*” section in Chapter 8 of this manual.)

### Checking The Defibtech Data Card (DDC card), If One Is Installed

Each time the DDU-2400/2450 AED is used, an event file is created on the DDC card (if installed). If the unit was used to treat a patient, the Defibtech Data Card (DDC card) in the unit should be removed and provided to the patient’s care provider. A new DDC card should be installed before the next use.

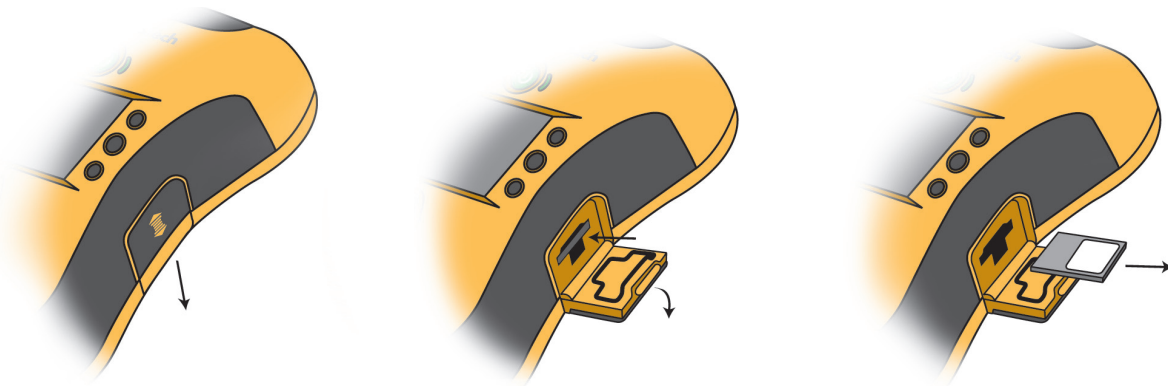

To remove the DDC card, ensure the AED is OFF. Locate the data card/USB port access door on the right-hand side of the unit. Open the data card/USB port access door by slightly pushing and then sliding the door down to release the latch. The door will spring open. To remove the DDC card, press the card in as far as it will go, and then release. Upon release, the DDC card will be partially ejected and can be removed by pulling the DDC card the rest of the way out.

To install a new DDC card, insert the DDC card into the thin slot in the side of the AED centered above the USB port opening, notched end first, label side up, until it clicks into place. The card should be flush with the surface of the slot. If the card does not push in all the way, it may have been inserted upside down. In that case, remove the card, flip it over, and try inserting it again.

Close the data card/USB port access door by closing and then pushing up the door until the door latch engages.

**Note:** A DDC card is not required for the DDU-2400/2450 AED to operate. Even if a DDC card is not installed, the unit will still record basic essential information internally. The AED will still operate properly even after a “replace data card” message.

## 7.2 Self-Tests

---

The DDU-2400/2450 AED provides for both automatic and manually initiated self-tests. These self-tests test various components of the AED, including the system controls, battery pack condition, charge/discharge functions, and measurement and signal acquisition functions.

### Automatic Unit Self-Tests

Every time the unit is turned on, power-on self-tests are performed to test the basic operation of the unit. The unit also performs daily, weekly, monthly, and quarterly self-tests automatically (without any intervention from the operator) to check the integrity of the unit's hardware and software. The unit will also perform a battery insert self-test when the battery pack is inserted.

### Manual Self-Tests

Manually initiated self-tests may be run at any time by the user to test the DDU-2400/2450 AED's systems, including the charging and shocking functions (the shock is internally dissipated; i.e., no voltage will be present at the pads).

To run a manually initiated AED test, the unit must be put into Maintenance Mode. (Refer to the *"AED Maintenance Screen"* section in Chapter 8 of this manual for detailed information on performing these self-tests.)

**Note:** Running a manually initiated self-test will consume approximately one shock's worth of energy from the battery.

## 7.3 Cleaning

---

After each use, clean the DDU-2400/2450 AED of any dirt or contaminants on the case and connector socket. The following are important guidelines to be adhered to when cleaning the device: (Also applies to ECG Monitoring Adaptor, DAC-2020/2021)

- The battery pack should be installed when cleaning the DDU-2400/2450 AED.
- Do not immerse the DDU-2400/2450 AED in fluids or allow fluids to enter the unit.
- Do not spray cleaning solutions directly on the unit or its connectors.
- Do not use abrasive materials or strong solvents such as acetone or acetone based cleaning agents.
- To wipe the DDU-2400/2450 AED's case clean, use a soft cloth dampened with one of the following recommended cleaning agents:
  - Soapy water
  - Ammonia based cleaners (e.g., Windex®, Formula 409®, Fantastik®)
  - Hydrogen peroxide
  - Isopropyl alcohol (70 percent solution)
  - Chlorine bleach (30 ml/liter water)
- Ensure that the connector socket is completely dry before reinstalling the pads cable. After cleaning, allow the unit to completely dry. Before returning it to service, always check the AED operational status. (Refer to *"Checking The AED Status Using The AED Status Screen"* earlier in this chapter.)

## 7.4 Storage

---

The DDU-2400/2450 AED should be placed in a readily accessible location in an orientation where the Active Status Indicator (ASI) next to the ON/OFF button can be easily seen. In general, the unit should be stored in clean, dry and moderate temperature conditions. Make sure that the environmental conditions of the storage location are within the ranges detailed in the *"Environmental"* section in Chapter 11 of this manual.

## 7.5 Operator's Checklist

The following checklist may be used as the basis for an Operator's Checklist. The table should be copied and filled out as recommend by the schedule in the *"Routine Unit Maintenance"* section of this chapter. As each item is completed it should be checked off.

<b>Defibtech DDU-2400/2450 Operator's Checklist</b>						
Defibtech DDU-2400/2450 AED Serial Number: _____						
Defibtech DDU-2400/2450 AED Location: _____						
<b>Date:</b>						
Check unit and accessories for damage, dirt, and contamination. Clean or replace as necessary.						
Check that spare battery pack and pads are available.						
Check that battery pack and pads are not past expiration dates.						
Check that the ASI is flashing green.						
Comments:						
Inspection by: (initials or signature)						

## 7.6 Troubleshooting

The following table lists the symptoms, the possible causes, and the possible corrective actions for common problems. Refer to the other sections of the user manual for detailed explanations on how to implement the corrective actions. If the unit continues to be non-functional, refer the unit for servicing. (Refer to [Chapter 14](#) of this manual for contact information.)

<b>Symptom</b>	<b>Possible Cause</b>	<b>Corrective Action</b>
<b>Unit will not turn on</b>	Battery pack not inserted	Insert battery pack
	Battery pack depleted or needs servicing	Replace battery pack or call for service
	Unit needs servicing	Call for service
<b>Unit immediately turns off</b>	Battery pack depleted	Replace battery pack
	Unit needs servicing	Call for service
<b>ASI flashes red and/or unit makes periodic "beep" sound.</b>	Unit needs servicing	Go to AED Status Screen by pressing the CENTER softkey button or call for service
	Battery pack non-functional	Replace battery pack
	Defibrillation pads are not pre-connected to unit	Connect defibrillation pads to unit
	Defibrillation pads or battery pack expired	Replace expired component
<b>ASI does not flash at all</b>	Battery pack not inserted	Insert battery pack
	Battery pack is low or needs servicing	Replace battery pack or call for service.
	Unit needs servicing	Call for service
<b>Power on test failed, service code "xxxx"</b>	Unit needs servicing	Record code number and call for service
<b>Battery test failed, service code "xxxx"</b>	Battery pack needs servicing	Record code number and call for service
<b>Service required</b>	Unit needs servicing	Call for service
<b>"Replace battery now" prompt</b>	Battery pack capacity is critically low	Unit may not deliver a shock, replace battery pack immediately
<b>"Battery low" prompt</b>	Battery pack capacity is getting low	Replace battery pack as soon as possible
<b>Display screen does not work</b>	Battery pack depleted	Replace battery pack
	Battery pack not inserted properly	Make sure battery pack is oriented correctly and fully inserted
	Unit needs servicing	Call for service
<b>"Plug in pads connector" prompt</b>	Pads connector not plugged in	Plug in pads connector
	Pads connector broken	Replace pads
	Unit's connector broken	Call for service

*Troubleshooting (continued)*

<b>Symptom</b>	<b>Possible Cause</b>	<b>Corrective Action</b>
<b>“Apply pads to patient’s bare chest as shown” prompt</b>	Pads not connected to patient	Place pads on patient
	Pads not making good connection to patient	Check pad connection to patient
	Pads or pad cable damaged	Replace pads
<b>“Poor pad contact to patient” or “Press pads firmly” prompt</b>	Dry pads	Replace pads
	Partial pad connection	Check that pads are placed securely on patient
<b>“Check pads” prompt</b>	Pads touching	Separate pads and place correctly on patient
<b>“Stop motion” prompt</b>	Patient motion has been detected	Stop patient motion
<b>“Stop interference” prompt</b>	External interference has been detected	Stop external interference
<b>“Analyzing interrupted” prompt</b>	Motion or interference detected	Stop motion or interference
<b>“Shock cancelled” prompt</b>	Patient’s ECG rhythm changed	No action necessary
	Shock button not pressed within 30 seconds	Press shock button within 30 seconds
	Low battery – insufficient to charge	Replace battery pack
	Bad pad to patient connection	Check that pads are placed securely on patient
	Dry pads	Replace pads
<b>“Replace data card” prompt</b>	DDC card is full	Replace DDC card with a card that is not full
	DDC card has failed	Replace DDC card
<b>“Pads missing” prompt</b>	Pads not connected to unit	Make sure pads connector is oriented correctly and fully inserted into unit

## **7.7 Repair**

The DDU-2400/2450 AED contains no user serviceable parts. If the unit needs servicing, call Defibtech. (Refer to [Chapter 14](#) of this manual for contact information.)

# 8 Maintenance Mode

## 8.1 Overview

Maintenance Mode for the Defibtech DDU-2400/2450 AED permits the user to perform maintenance-related actions such as viewing unit information, initiating unit self-tests, changing unit parameters, downloading rescue data, and upgrading software.

Maintenance Mode is navigated through a series of screens, menus, and menu options. In Maintenance Mode, the softkey buttons located directly to the right of the display screen are used to scroll through and select menu options. When a softkey icon (for example, an arrow) appears on the display screen directly to the left of a softkey button, the softkey button is functional for that screen. If a softkey icon is not displayed on the screen, then the corresponding softkey button has no functionality for that screen.

**Note:** While the unit is in Maintenance Mode, it cannot perform a rescue. Maintenance Mode allows the user to go directly to AED Mode by selecting the **Rescue now** option. The **Rescue now** option appears at the top of every screen/menu when the unit is in Maintenance Mode. The user can also exit Maintenance Mode at any time and go to AED Mode by pressing the ON/OFF button to turn the unit off and then immediately pressing the ON/OFF button again to turn the unit back on.

### The Display Screen (During Maintenance Mode):

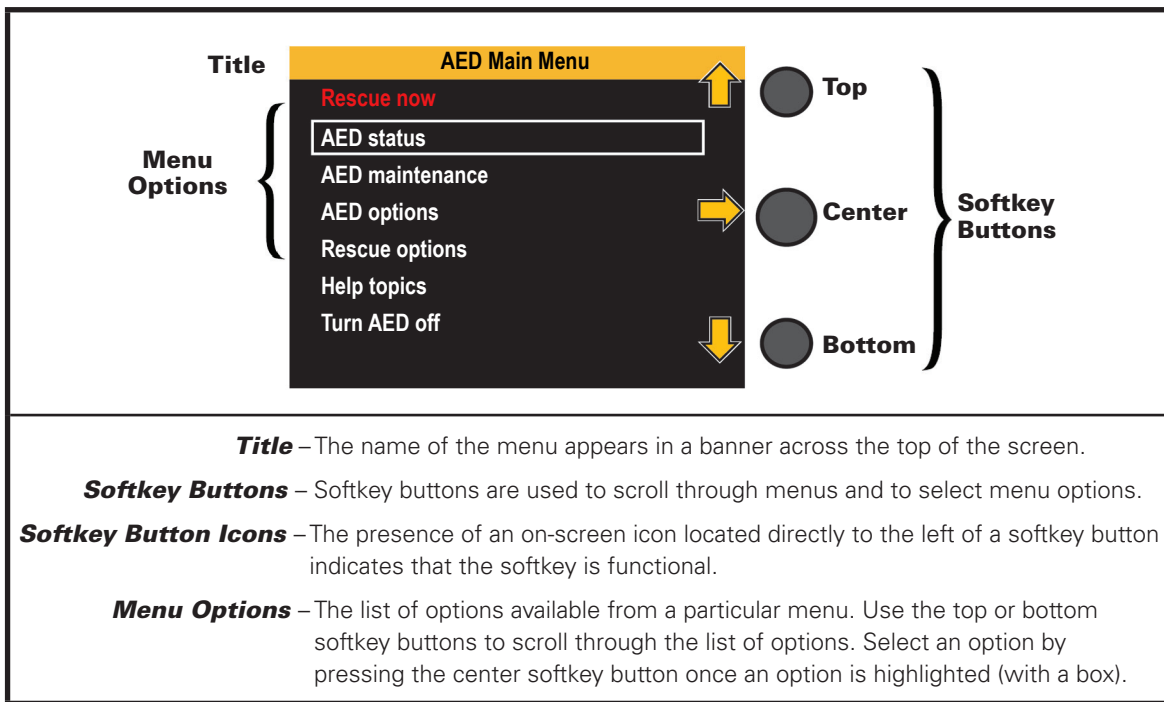

## 8.2 Navigation (in Maintenance Mode)

The three softkey buttons located to the right of the display screen are used to navigate in Maintenance Mode. Typical functions of the softkey buttons are the following:

- Top softkey button: Scroll up
- Center softkey button: Select highlighted option
- Bottom softkey button: Scroll down

When a menu option is highlighted and then selected (typically by pressing the CENTER softkey button), either another screen will be displayed with additional menu options or an action will be performed.

### Exiting Maintenance Mode

To exit Maintenance Mode and return to Rescue Mode, scroll to and select **Rescue now** or simply turn the unit off and then back on.

To exit Maintenance Mode and turn the unit off, scroll to and select **Turn AED off** or simply turn the unit off by pressing the ON/OFF button.



## 8.3 Entering Maintenance Mode

**Before You Begin:** Make certain the DDU-2400/2450 AED is turned off and a battery pack is installed.

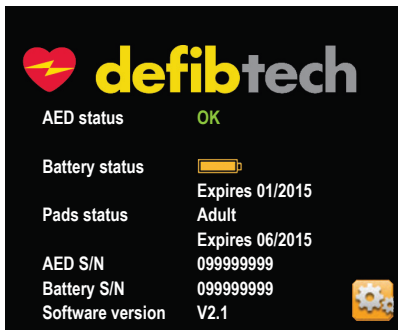

**STEP 1** – Press and release the CENTER softkey button.

**Result** – The unit will turn on and display the AED Status Screen for a short period of time.

If the unit does not turn on, check to make sure a good battery pack is installed. (Refer to the “*Troubleshooting*” section in Chapter 7 of this manual.)

**STEP 2** – Press the **BOTTOM** softkey button (to the right of the Tool Icon). **Note:** If the bottom softkey button is not pressed within a short period of time, the unit will automatically turn off.

**Result** – The unit will enter Maintenance Mode and display the AED Main Menu screen.

### 8.4 AED Main Menu Screen

The AED Main Menu Screen allows the user to view the status of the AED, perform maintenance functions, change AED options, and access help topics. All maintenance functions are accessed through the AED Main Menu Screen. The user may select from the following options using the softkey buttons:

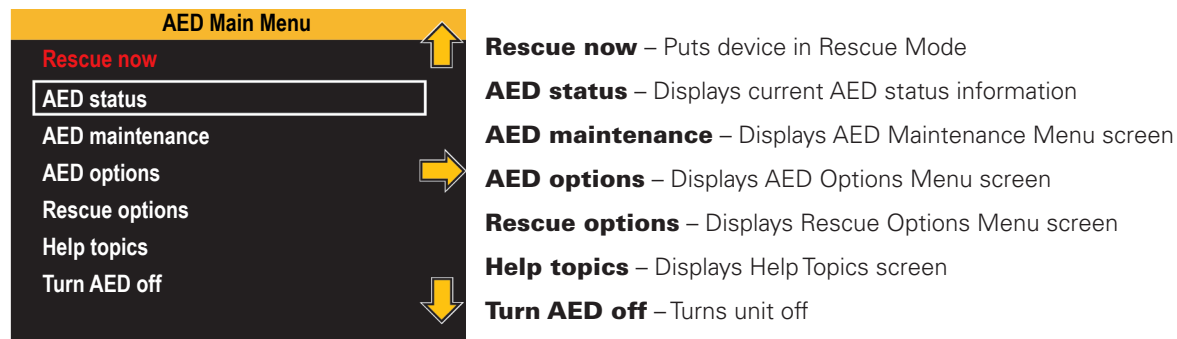

When the user selects “Rescue now,” the unit will exit Maintenance Mode and proceed directly to Rescue Mode. The other menu options will perform different functions and are described in detail below.

### 8.5 AED Status Screen

The AED Status Screen displays unit-specific data such as current status, battery pack charge state, battery pack expiration date, defibrillation pads expiration date, unit serial number, battery pack serial number, and software version number.

**Before you begin:** Be sure the unit is in Maintenance Mode.

**To enter:** Navigate to **AED status**:

**AED Main Menu → AED status**

**Note:** When the unit is turned off, the AED Status Screen can also be accessed by pressing the center softkey button.

**What it does:** The unit will display the AED Status Screen. This is an informational screen only; no action is taken by the AED.

**To exit:** To exit the AED Status Screen, press and release the BOTTOM softkey button. The unit will exit the AED Status Screen and return to the AED Main Menu screen.

## 8.6 AED Maintenance Screen

The **AED Maintenance** screen allows the user to select such options as AED tests, software upgrades, data backups, and data card functions.

**Before you begin:** Be sure the unit is in Maintenance Mode.

**To enter:** Navigate to **AED Maintenance**:

**AED Main Menu → AED maintenance**

**What it does:** The unit will display the AED Maintenance menu screen. This screen will allow the user to navigate further to perform various maintenance tasks:

- **Perform AED test**
- **Upgrade AED**
- **Transfer data to card**
- **Format data card**
- **Run application from card**

**To exit:** Use the TOP or BOTTOM softkey buttons to scroll to and highlight the selection “Go to main menu.” Press the CENTER softkey button. The unit will exit the AED Maintenance screen and return to the AED Main Menu screen.

### ➔ Perform AED Test

**Perform AED test** will initiate a system hardware and software self-test.

**Note:** Running manually initiated AED tests will consume approximately one shock’s worth of battery life.

**Before you begin:** Be sure the unit is in Maintenance Mode.

**To enter:** Navigate to **Perform AED test**:

**AED Main Menu → AED maintenance → Perform AED test**

**What it does:** When the user selects “Perform AED test” selection and presses the CENTER softkey button, the unit will begin performing the self-test procedure:

The unit says: “Performing AED test”

The unit displays: Testing AED

The unit will then prompt the user to “Press flashing shock button.” Continue to follow the directions until the test is complete. Once the AED test is complete the unit will verbally and visually report the status of the AED. The information will be displayed in a pop-up window. The user must press any softkey button to confirm the test status and return to the AED Maintenance screen.

If self-test passes: The unit will speak and display: “AED OK”

If self-test fails: The unit will display an error screen with text prompts providing instructions to address the condition.

**Note:** If self-test fails, the user should follow the text prompts to address the condition requiring attention or refer to the “*Troubleshooting*” section in Chapter 7 of this manual.

**To exit:** Press any softkey button. The self-test status pop-up window will clear and the display will return to the AED Maintenance menu screen.

### ➔ Upgrade AED

The **Upgrade AED** menu selection is a method of performing a unit upgrade and will activate the system upgrade procedure from a Defibtech Data Card (DDC card) containing an upgrade application.

**Note:** Upgrades can also be performed directly from the AED Status Screen if an upgrade card is present when the AED Status Screen mode is launched.

**Before you begin:** Be sure the unit is in Maintenance Mode.

**To enter:** Navigate to **Upgrade AED**:

**AED Main Menu → AED maintenance → Upgrade AED**

**What it does:** If an upgrade data card is present, the unit will start performing the upgrade process. Follow any prompts and instructions that the upgrade application provides.



Do not turn off the unit or remove the battery pack or data card until the operation is complete.

**Note:** If the DDC card is not inserted, the unit will speak and display “Data Card Missing.” (Refer to the “*Installing The Defibtech Data Card (DDC card)*” section in Chapter 3 of this manual.) Press any softkey button to acknowledge the message and then install a Defibtech Data Card (DDC card).

**To exit:** When the unit finishes performing the AED upgrade, follow the displayed and spoken instructions.

#### ➔ Transfer Data To Card

**Transfer data to card** will initiate a data transfer from the DDU-2400/2450 AED to a Defibtech Data Card (DDC card) inserted in the device. Internal event data and device history is written to the DDC card.

**Before you begin:** Be sure the unit is in Maintenance Mode. Be sure a DDC Card is installed in the device. (Refer to the “*Installing The Defibtech Data Card (DDC card)*” section in Chapter 3 of this manual.)

**To enter:** Navigate to **Transfer data to card**:

**AED Main Menu → AED maintenance → Transfer data to card**

**What it does:** The unit begins transferring rescue data to the card:

The unit says: “Transferring data to data card”

The unit displays: Transferring Data

The unit will finish transferring data to the data card and will speak and display: “data transfer complete”



Do not turn off the unit or remove the battery pack or data card until the operation is complete.

**Note:** If a data card is not inserted, the unit will speak and display “Data Card Missing.” (Refer to the “*Installing The Defibtech Data Card (DDC card)*” section in Chapter 3 of this manual.)

**To exit:** When the unit finishes transferring the data to the data card, it will automatically return to the AED Maintenance menu screen.

#### ➔ Format Data Card

**Format data card** is a maintenance tool used to repair corrupted cards. It is unnecessary to perform this step on cards purchased with your DDU-2400/2450 AED.



This step will erase all data on the data card!

**Before you begin:** Be sure the unit is in Maintenance Mode. Be sure a Defibtech Data Card (DDC card) is currently installed in the device. (Refer to the “*Installing The Defibtech Data Card (DDC card)*” section in Chapter 3 of this manual.)

**To enter:** Navigate to **Format data card**:

**AED Main Menu → AED maintenance → Format data card**

**What it does:** The unit will format the DDC card that is inserted in the AED:

The unit says: "Formatting data card"

The unit displays: Formatting Data Card

When unit finishes formatting the DDC card, the unit will return to the menu.



Do not turn off the unit or remove the battery pack or data card until the operation is complete.

**Note:** If the data card is not inserted, the unit will speak and display "Data Card Missing." (Refer to the "*Installing The Defibtech Data Card (DDC card)*" section in Chapter 3 of this manual.)

**To exit:** When the unit finishes formatting the data card, it will automatically return to the AED Maintenance menu screen.



Using non-Defibtech Data Cards (DDC cards) may damage the unit and will void the warranty.

#### ➔ Run Application From Card

**Run application from card** will initiate a card application on the Defibtech Data Card (DDC card). The most typical application is a software upgrade.

**Before you begin:** Be sure the unit is in Maintenance Mode. Be sure a DDC Card, with a card application, is installed in the device. (Refer to the "*Installing The Defibtech Data Card (DDC card)*" section in Chapter 3 of this manual.)

**To enter:** Navigate to **Run application from card**:

**AED Main Menu → AED maintenance → Run application from card**



Do not turn off the unit or remove the battery pack or data card until the operation is complete.

**Note:** If a data card is not inserted, the unit will speak and display "Data Card Missing." Refer to the "*Installing The Defibtech Data Card (DDC card)*" section in Chapter 3 of this manual.)

**To exit:** When the unit finishes performing the application, follow the displayed and spoken instructions.

## 8.7 AED Options Screen

To manually configure AED options such as time, date, volume, and audio recording, select the **AED options** from the AED Main Menu screen.

**Before you begin:** Be sure the unit is in Maintenance Mode.

**To enter:** Navigate to **AED options**:

**AED Main Menu → AED options**

**What it does:** The unit will display the AED options menu screen. This screen will allow the user to modify the following user changeable parameters:

- **System time**
- **System date**
- **Volume level**
- **Audio recording**

**To exit:** Using the TOP or BOTTOM softkey buttons, scroll to and highlight the selection

**Go to main menu.** Press the CENTER softkey button. The unit will exit the AED options menu screen and return to the AED Main Menu.

### ➔ System Time

The **System time** option allows the user to set the time of the internal AED clock.

**Before you begin:** Be sure the unit is in Maintenance Mode.

**To enter:** Navigate to **System time**:

**AED Main Menu → AED options → System time**

**What it does:** The **System time** option allows the user to set the time of internal AED clock (using the 24 hour clock). Once the **System time** option is selected, press the CENTER softkey button to enter set time mode:

The hours selection will be highlighted green:

- Press the TOP or BOTTOM softkey buttons to adjust the hours to the desired time.
- Press the CENTER softkey button to accept the hours setting.

The minutes selection will be highlighted green:

- Press the TOP or BOTTOM softkey buttons to adjust the minutes to the desired time.
- Press the CENTER softkey button to accept the minutes setting.

The seconds selection will be highlighted green:

- Press the TOP or BOTTOM softkey buttons to adjust the seconds to the desired time.
- Press the CENTER softkey button to accept the seconds setting.

The time is now set and the user may use TOP or BOTTOM softkey buttons to navigate to other choices in the menu.

**Note:** The factory default setting of the internal AED clock is Universal Time (GMT).

### ➔ System Date

The **System date** option allows the user to set the date of the internal AED clock.

**Before you begin:** Be sure the unit is in Maintenance Mode.

**To enter:** Navigate to **System date**:

**AED Main Menu → AED options → System date**

**What it does:** The **System date** option allows the user to set the date of internal AED clock. Once the **System date** option is selected, press the CENTER softkey button to enter set date mode:

The year selection will be highlighted green:

- Press the TOP or BOTTOM softkey buttons to adjust the year.
- Press the CENTER softkey button to accept the year setting.

The month selection will be highlighted green:

- Press the TOP or BOTTOM softkey buttons to adjust the month.
- Press the CENTER softkey button to accept the month setting.

The day selection will be highlighted green:

- Press the TOP or BOTTOM softkey buttons to adjust the day.
- Press the CENTER softkey button to accept the day setting.

The date is now set and the user may use TOP or BOTTOM softkey buttons to navigate to other choices in the menu.

**Note:** The factory default setting of the internal AED clock is Universal Time (GMT).

### ➔ Volume Level

The **Volume level** option allows the user to set AED audio output to **high, medium, or low** volume. Changing the volume level will not change the volume of the Active Status Indicator “beep.”

**Before you begin:** Be sure the unit is in Maintenance Mode.

**To enter:** Navigate to **Volume level:**

**AED Main Menu → AED options → Volume level**

**What it does:** The **Volume level** option allows the user to set AED audio to **high, medium or low** volume. Once the **Volume level** option is selected, use the TOP and BOTTOM softkey buttons to cycle through the different volume settings. When the desired volume selection is chosen, press the CENTER softkey button to set that volume level. The AED will now use that volume setting for all audio (except the volume of the Active Status Indicator “beep”). The user may use the TOP or BOTTOM softkey buttons to navigate to other choices in the menu.

**Note:** The factory default setting of the volume level is “**high**.”

### ➔ Audio Recording

The **Audio recording** option allows the user to enable or disable recording of event audio data to a Defibtech Data Card (DDC card).

**Before you begin:** Be sure the unit is in Maintenance Mode.

**To enter:** Navigate to **Audio recording:**

**AED Main Menu → AED options → Audio recording**

**What it does:** The **Audio recording** option allows the user to enable/disable recording of event audio data. Once the **Audio recording** option item is selected, use the TOP and BOTTOM softkey buttons to select either enabled or disabled settings. When the desired selection is chosen, press the CENTER softkey button to set the feature. The AED will now use that audio recording setting. The user may use the TOP or BOTTOM softkey buttons to navigate to other choices in the menu.

**Note:** The factory default setting of the audio recording is “**disabled**.”

## 8.8 Rescue Options Screen

To manually configure rescue options such as Rescue protocol and CPR breathing, select the **Rescue options** from the AED Main Menu screen.

**Before you begin:** Be sure the unit is in Maintenance Mode.

**To enter:** Navigate to **Rescue options:**

**AED Main Menu → Rescue options**

**What it does:** The unit will display the Rescue options menu screen. This screen will allow the user to modify certain user changeable parameters:

- **CPR breathing**
- **Rescue protocol**
  - **Settings**
- **Default view**
- **Manual Mode enable**

**To exit:** Using the TOP or BOTTOM softkey buttons, scroll to and highlight the selection **Go to main menu**. Press the CENTER softkey button. The unit will exit the Rescue options menu screen and return to the AED Main Menu.

### ➔ CPR Breathing

The **CPR breathing** option allows the user to enable or disable the CPR breathing coaching prompts during CPR.

**Before you begin:** Be sure the unit is in Maintenance Mode.

**To enter:** Navigate to **CPR breathing**:

**AED Main Menu → Rescue options → CPR breathing**

**What it does:** **CPR breathing** allows the user to enable/disable CPR breathing coaching prompts.

Use the TOP and BOTTOM softkey buttons to select the desired mode. When the desired selection is chosen, press the CENTER softkey button to set the feature. The AED will now use that coaching setting.

**Note:** The factory default setting of CPR breathing is set to “**disabled**.”

### ➔ Rescue Protocol

The AED supports two rescue protocols at one time. The **Rescue protocol** option allows the user to select a rescue protocol. Rescue protocol options include the AHA/ERC 2010 protocol or “Custom.”

**Before you begin:** Be sure the unit is in Maintenance Mode.

**To enter:** Navigate to **Rescue protocol**:

**AED Main Menu → Rescue options → Rescue protocol**

**What it does:** The **Rescue protocol** option allows the user to select between up to two rescue protocols that have been enabled in the unit. The factory default setting of the rescue protocol is AHA/ERC 2010.

To change the protocol, press the CENTER softkey button to highlight the protocol. The user will be prompted to enter a password to proceed. The password may be obtained from your medical director or from Defibtech. (For Defibtech contact information, please refer to the “*Contacts*” section in Chapter 14.) Once the password has been entered, the user may select between the two protocols.

To enter the password use the TOP softkey button to scroll through numbers. Once the correct number appears, use the CENTER softkey button to move to the next space. Once all of the numbers have been entered press the CENTER softkey button. The user will now be able to choose a different rescue protocol.

### ➔ Settings

**Before you begin:** Be sure the unit is in Maintenance Mode.

**To enter:** Navigate to **Settings**:

**AED Main Menu → Rescue options → Settings**

**What it does:** The **Settings** option allows the user to change the currently enabled protocol by entering a special protocol code. This code is a special code that encodes all the important information regarding the protocol. This code is custom generated by Defibtech. If the code is not entered correctly the protocol will not be changed. Based on the protocol code entered, the currently selected protocol will be changed to that described by the special protocol code. You can obtain this code from your medical director or from Defibtech. (For Defibtech contact information, please refer to the “*Contacts*” section in Chapter 14.) Once the code has been entered, the settings will have been changed.

To enter the code use the TOP softkey button to scroll through numbers/letters. Once the correct number/letter appears, use the CENTER softkey button to move to the next space. Once all of the numbers/letters have been entered, press the CENTER softkey button. The settings will have been changed based on the code entered.

### ➔ Default View

The **Default view** option allows the user to select Video or ECG as the default view when the AED is powered.

**Before you begin:** Be sure the unit is in Maintenance Mode.

**To enter:** Navigate to **Default view**:

**AED Main Menu → Rescue options → Default view**

**What it does:** Selects which view the AED presents on power up.

Use the TOP and BOTTOM softkey buttons to select the desired view. When the desired selection is chosen, press the CENTER softkey button to set the feature. The AED will now use that default view setting.

**Note:** The factory default setting is set to “**Video**.”

### ➔ Manual Mode Enable

The **Manual Mode enable** option allows the user to enable or disable the Manual override feature of the DDU-2400 (only).

**Before you begin:** Be sure the unit is in Maintenance Mode.

**To enter:** Navigate to **Manual Mode enable**:

**AED Main Menu → Rescue options → Manual Mode enable**

**What it does:** Enables or Disables the Manual Mode feature of the AED (DDU-2400 only).

Use the TOP and BOTTOM softkey buttons to select the desired mode. When the desired selection is chosen, press the CENTER softkey button to set the feature. The AED will now use that setting.

**Note:** The factory default setting is set to “**Enabled**.” This menu item is only available in the DDU-2400

## 8.9 Help Topics Screen

The **Help Topics** option on the AED Main Menu provides a list of available help topics.

**Before you begin:** Be sure the unit is in Maintenance Mode.

**To enter:** Navigate to **Help topics**:

**AED Main Menu → Help topics**

**What it does:** The Help topics provides a list of available help topics.

The Help topics are the following:

- **Preparing the patient**
- **Analyzing and shocking**
- **Performing CPR**
- **Replacing the battery**
- **Replacing the pads**
- **Checking the AED status**
- **Replacing the data card**

Use the TOP and BOTTOM softkey buttons to scroll through the different Help topics items. When the desired help selection is highlighted (with a box), press the CENTER softkey button to get more information.

**To exit:** Using the TOP or BOTTOM softkey buttons, scroll and highlight the selection **Go to main menu**. Press the CENTER softkey button. The unit will exit the Help Topics menu screen and return to the AED Main Menu.



## 9 DDU-2400/2450 AED Accessories

This chapter describes the component parts and the accessories that can be used with the Defibtech DDU-2400/2450 AED. For contact information on obtaining replacement component parts and accessories, refer to [Chapter 14](#) in this manual.

### 9.1 Defibrillation Pads

The DDU-2400/2450 AED must be used with Defibtech self-adhesive defibrillation pads for adults or with child/infant pads for infants and children. These defibrillation pads serve two functions:

- Allow the unit to read the patient's electrocardiograph (ECG) rhythm.
- Deliver defibrillation energy to the patient if needed.

The Defibtech self-adhesive defibrillation pad assembly comes in a "leads-out" sealed package that allows the device to be stored with the pads connected to the AED. When the DDU-2400/2450 AED is used, the operator needs only to turn the device on, remove the pad package, tear open the package, remove the pads from the blue liner, apply the pads to the patient, and administer care. The AED has a storage area in the back of the unit that allows for storage of a single sealed adult pads package.

### 9.2 Battery Packs

The DDU-2400/2450 AED uses a lithium battery pack to provide the AED with a long shelf and standby life. The battery pack is inserted into the battery pack opening on the back of the AED and latches into place. Battery packs are not rechargeable.

### 9.3 Data Cards

The DDU-2400/2450 AED is designed to optionally use Defibtech Data Cards (DDC cards). The AED will operate with or without a DDC card, but if a DDC card is installed, additional event storage capacity is available.

The DDU-2400/2450 AED accepts DDC cards capable of recording an assortment of data for a given period of time. The DDU-2400/2450 allows the user to enable or disable recording of audio data. (Refer to the *"AED Options Screen"* section in Chapter 8 of this manual.)

The DDC card is inserted into a slot behind the data card/USB port access door found on the side of the AED. (Refer to the *"Installing The Defibtech Data Card (DDC card)"* section in Chapter 3 of this manual.) A new event file is created on the DDC card each time the AED is turned on, and the following information is recorded:

- The time the AED was turned on.
- Other data such as: ECG data, time data, audio data (audio enabled card only), event milestones such as: motion detection, shock advice, shock delivery information.

Multiple events may be recorded on a single DDC card. If the DDC card becomes full, the AED will stop recording to the card, however, the most critical event documentation for the current session will still be recorded internally.

Internally recorded event information can be downloaded for external review by inserting a blank DDC card into the unit and following the Data Download procedure. (Refer to the *"Downloading The Internal Data Log"* section in Chapter 10 of this manual.)



Using non-Defibtech Data Cards (DDC cards) may damage the unit and will void the warranty.

## 9.4 USB Cable

---

An optional USB cable may be used with the DDU-2400/2450 AED for connecting the AED to a personal computer running Defibtech maintenance software. The AED has a mini-USB connector located on the right side of the unit behind the data card/USB port access door.



Do not have a USB cable attached to the unit during a rescue.

## 9.5 ECG Monitoring Adaptor

---

An optional ECG Monitoring Adaptor cable (DAC-2020/2021) may be used with the DDU-2400/2450 AED to provide a non-diagnostic ECG display of the patient's heart rhythm for attended patient monitoring. The adaptor uses the same connector socket in the AED used by the defibrillation pads.

# 10 Event Viewing

This chapter includes information about DefibView II, Defibtech Data Cards (DDC cards), and downloading internal data logs.

## 10.1 DefibView II

DefibView II is a Windows-based software application that reads data stored on a DDC card or downloaded through the USB port and displays the data on a personal computer. DefibView II serves the following primary functions:

- Enables emergency care personnel to review a cardiac episode from the time the AED was turned on and connected to the patient until the unit is turned off.
- Provides maintenance personnel with additional parameter information to assist in troubleshooting a device suspected of malfunctioning.

DefibView II is a stand-alone software application. DefibView II cannot be used while the AED is in operation, and its function is solely to support post-event review.



Not intended for clinical use. Information presented by DefibView II should not be used for making clinical decisions.

## 10.2 Defibtech Data Cards (DDC Cards)

If a DDC card is installed in the unit, every time the DDU-2400/2450 AED is turned on, the following information is recorded on a new file on the card:

- The time the AED was turned on.
- Other data such as: ECG data, time data, audio data (audio enabled cards only), event milestones such as: motion detection, shock advice, shock delivery information.

This information can be reviewed using the DefibView II application.



Using non-Defibtech Data Cards (DDC cards) may damage the unit and will void the warranty.

## 10.3 Downloading The Internal Data Log

Regardless of whether a DDC card is installed in the unit, select information is recorded internally within the DDU-2400/2450 AED. The information recorded is limited to:

- The time the AED was turned on.
- Other data such as event milestones (motion detection, shock advice, shock delivery information, etc.)
- Important ECG information.

**Note:** Audio data is not logged internally.

### Downloading The Internal Data Log Using The DDC Card

To download the internally logged information, perform the following procedure:

- Insert a DDC card into the unit.
- Turn the unit on in Maintenance Mode by pressing the center softkey button.
- Press the tool icon to enter the AED Maintenance screen.
- From the AED Maintenance screen select the **Transfer Data To Card** option.
- Allow the unit to write the contents of the internal log to the DDC card.

The DDU-2400/2450 AED will write the contents of the internal log onto the DDC card. This information can then be reviewed using DefibView II software.

### Downloading The Internal Data Log Using The USB Port

To download the internal data log using the USB port in the unit, connect a USB cable between the unit and a PC. Launch the DefibView II software and follow USB download directions.



Do not operate the DDU-2400/2450 AED in Rescue Mode while a USB cable is plugged into the unit.

# 11 Technical Specifications

## 11.1 Defibtech DDU-2400/2450 AED

### General

Category	Specification
Size	7.3 x 9.5 x 2.3 inches 18.5 x 24 x 5.8 cm
Weight	Less than 3 lbs (1.4 kg) (with battery)
Power	Battery Pack (not rechargeable)
Design standards	Meets applicable requirements of <ul style="list-style-type: none"> <li>• IEC 60601-1</li> <li>• UL 60601-1</li> <li>• CAN/CSA C22.2 No.601.1-M90</li> <li>• IEC 60601-1-2</li> <li>• IEC 60601-2-4</li> <li>• AAMI DF80</li> </ul>
Device Classification	Internally powered with defibrillator-proof BF-type patient applied parts (per EN 60601-1)
Patient safety	All patient connections are electrically isolated.

### Defibrillator – AED Mode

Category	Specification
Waveform	Impedance Compensated Biphasic Truncated Exponential
Energy	Adult: 150 Joules (nominal [+/-15%] delivered into a 50 ohm load) Child/Infant: 50 Joules (nominal [+/-15%] delivered into a 50 ohm load)
Charge control	Automatic by Patient Analysis System
Charge time	4 seconds or less (from shock advised)* Charge time may increase at the end of battery life and for temperatures below 10°C.
Charge time from the initiation of rhythm analysis to readiness for discharge	Meets or exceeds AAMI DF80 and IEC 60601-2-4 requirements
Charge time measured from initially switching power on to charge ready	Meets or exceeds AAMI DF80 and IEC 60601-2-4 requirements
Charge complete indication	<ul style="list-style-type: none"> <li>• SHOCK button flashing</li> <li>• “Press flashing shock button” voice prompt</li> </ul>
Shock delivery	Shock is delivered by a single SHOCK button
DISARM	Automatic <ul style="list-style-type: none"> <li>• If Patient Analysis System decides rhythm is no longer shockable, or</li> <li>• Within 30 seconds after charge complete, if operator has not pressed SHOCK button,</li> </ul> or <ul style="list-style-type: none"> <li>• If defibrillation pads are removed from patient or unplugged from unit.</li> </ul>
	Manual <ul style="list-style-type: none"> <li>• If operator presses and holds the ON/OFF button for approximately two seconds, device will disarm and turn off.</li> </ul>

\*Typical, new battery, at 25°C

**Defibrillator – Manual Mode** (DDU-2400 only)

Category		Specification
Energy		User selectable: 25, 50, 70, 100, 150, 200 Joules (adult defibrillation pads) 25, 50, 70, 100, Joules (pediatric defibrillation pads) <b>Note:</b> energy is limited to 50 J only, when using DDP-2002 (attenuating pediatric defibrillation pads)
Charge control		User initiated, CHARGE softkey
Charge time		See <a href="#">battery charge time specifications</a> in Section 11.2 of this manual
Charge complete indication		<ul style="list-style-type: none"> <li>• SHOCK button flashing</li> <li>• Two tone alarm</li> </ul>
Shock delivery		Shock is delivered by a single SHOCK button
DISARM	Automatic	<ul style="list-style-type: none"> <li>• Within 30 seconds after charge complete, if operator has not pressed SHOCK button,</li> <li>or</li> <li>• If defibrillation pads are removed from patient or unplugged from unit.</li> </ul>
	Manual	<ul style="list-style-type: none"> <li>• If operator presses the manual DISARM softkey or ON/OFF button pressed for greater than 2 seconds</li> </ul>

**Display**

Category	Specification
Displayed ECG	ECG information is received from defibrillation pads in anterior-lateral or anterior-posterior positions, or from the 3-wire ECG Monitor Adaptor in Lead II
Screen type	TFT Color LCD with backlight (53.6mm x 71.5mm) (320 x 240 pixels)
Displayed Range	Differential: +/- 2 mV full-scale
Sweep Speed	25 mm/sec
Frequency Response	1 Hz to 22 Hz (-3 dB), nominal
Sensitivity	10 mm/mV, nominal
Heart rate display	20 to 200 bpm, updated once/second <ul style="list-style-type: none"> <li>• Displayed when ECG viewing is enabled</li> <li>• An out of range heart rate is indicated by dashed lines in the display</li> </ul>

**Note:** The ECG Display provides non-diagnostic ECG of the patient's heart rhythm. It is not intended to provide diagnostic or ST segment interpretation.

**Note:** The ECG waveform sensitivity and magnification settings are fixed and are not user adjustable.

### Waveform Specifications

In AED Mode, the DDU-2400/2450 AED delivers a 150 J (Adult) 50 J (Pediatric) Biphasic Truncated Exponential waveform (AED Mode) to patients with impedances ranging from 25 to 180 ohms. In Manual Mode, the user can select the energy level.

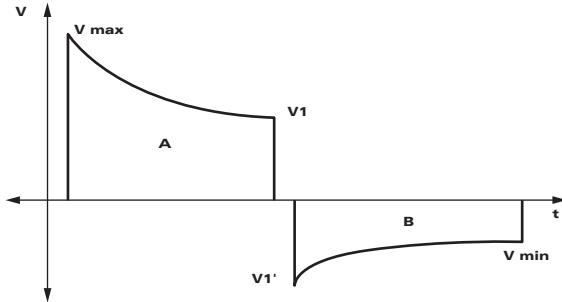

The waveform is adjusted to compensate for measured patient impedance. Nominal phase times and energy delivered are shown in the tables below.

#### Phase Times (DDP-2001 Adult and DDP-2003 Pediatric Defibrillation Pads)

Patient Impedance (Ohms)	Phase A Duration (ms)	Phase B Duration (ms)
25	2.8	2.8
50	4.1	4.1
75	7.2	4.8
100	9.0	6.0
125	12.0	8.0
150	12.0	8.0
175	12.0	8.0

#### Energy – AED Mode (DDP-2001 Adult Defibrillation Pads) (Nominal)

		Load Impedance (Ohms)						
Nominal		25	50	75	100	125	150	175
150 J		153	151	152	151	153	146	142

#### Energy – AED Mode (DDP-2003 Non-attenuating Pediatric Defibrillation Pads) (Nominal)

		Load Impedance (Ohms)						
Nominal		25	50	75	100	125	150	175
50 J		50	50	51	51	51	50	49

**Energy – Manual Mode** (DDP-2001 Adult and DDP-2003 Non-attenuating Pediatric Defibrillation Pads) (Nominal)

<b>Load Impedance (Ohms)</b>							
<b>Selected Energy</b>	25	50	75	100	125	150	175
25 J	25	25	26	26	26	25	25
50 J	50	50	51	51	51	50	49
70 J	70	70	71	71	72	70	68
100 J	99	100	101	101	102	100	97
150 J	153	151	152	151	153	146	142
200 J	194	195	198	197	201	195	189

DDP-2003 pediatric defibrillation pads Selected Energy range is limited from 25 to 100 J.

**Phase Time and Energy** (DDP-2002 Attenuating Pediatric Defibrillation Pads)

<b>Patient Impedance (Ohms)</b>	<b>Phase A Duration (ms)</b>	<b>Phase B Duration (ms)</b>	<b>Energy Delivered (Joules)</b>
25	4.1	4.1	35
50	5.8	3.8	47
75	5.8	3.8	51
100	7.2	4.8	53
125	7.2	4.8	52
150	9	6	53
175	9	6	51

Applies to both AED and Manual Modes.

**Note:** If impedance is out of range for proper analysis and shock delivery, voice and/or visual prompts will inform the user.

**Environmental**

Category		Specification
Operating/ Maintenance	Temperature	0 – 50°C (32 – 122°F)
	Humidity	5% – 95% (non-condensing)
	Air Pressure	700 to 1060 hPa (21 to 31 inHg)
Standby/Storage/ Transport	Temperature	0 – 50°C (32 – 122°F)
	Humidity	5% – 95% (non-condensing)
	Air Pressure	500 to 1060 hPa (15 to 31 inHg)
Altitude		-150 to 4500 meters (-500 to 15,000 feet) per MIL-STD-810F 500.4 Procedure II
Shock/Drop Abuse Tolerance		MIL-STD-810F 516.5 Procedure IV 48 in, (1.2 meters), any edge, corner, or surface, in standby mode
Crush test		1,000 lbs (450 kg)
Vibration		MIL-STD-810F 514.5 Category 20 (Ground) RTCA/DO-160D, Section 8.8.2, Cat R, Zone 2, Curve G (Helicopter) RTCA/DO-160D, Section 8, Cat H, Zone 2, Curves B & R (Jet Aircraft)
Sealing/Water Resistance		IEC60529 class IP55; Dust Protected, Protected against water jets (Battery pack installed)
ESD and EMI (radiated and immunity)		Refer to <a href="#">Chapter 12</a> for details
Radio Frequency Emissions Applicable Directive and Standards		R&TTE Directive 1999/5/EC ETSI EN 300 220-2 V2.1.2 (2007-06) ERC RECOMMENDATION 70-03 ETSI EN 301 489-3 V1.4.1 (2002-08)



**Patient Analysis System**

The DDU-2400/2450 Patient Analysis System ensures that the pad/patient impedance is within the proper range and analyzes the patient’s ECG rhythm to determine whether a shock is required. On detection of a non-shockable rhythm, the user is prompted to perform CPR. For shockable rhythms, the AED automatically charges in preparation for shock delivery.

The patient analysis system will detect electrical “noise” or artifact in the ECG signal that may interfere with accurate rhythm analysis. This artifact may be caused by excessive motion to the patient or by external electrical noise. When this artifact is present, the AED will prompt the user to “Stop motion” or “Stop Interference” until the ECG signal is free of noise and then proceed to analysis.

**Shockable Rhythm Criteria**

When placed on a patient meeting the indications for use criteria, the DDU-2400/2450 AED is designed to recommend a defibrillation shock when it detects proper pad impedance and one of the following:

<b>Ventricular Fibrillation:</b> Peak-to-peak amplitude at least 200 µVolts.	
	Some very low amplitude or low frequency VF rhythms may not be interpreted as shockable.
<b>WARNING</b>	
<b>Ventricular Tachycardia</b> (Including ventricular flutter and polymorphic VT): Cardiac rhythm rate of at least 180 bpm and peak-to-peak amplitude at least 200 µVolts.	
	Some very low amplitude or low frequency VT rhythms may not be interpreted as shockable.
<b>WARNING</b>	

The DDU-2400/2450 AED is designed to recommend *no* shock for all other rhythms, including Normal Sinus Rhythms, fine Ventricular Fibrillation (<200 µVolts), and some slow Ventricular Tachycardia and Asystole.



**Patient Analysis System Performance**

Rhythm Class	ECG Test Sample <sup>1</sup> Size	Algorithm Performance <sup>3</sup>		Specifications
		Performance <sup>2</sup>	90% Lower Confidence Limit <sup>2</sup>	
Shockable Rhythm – Ventricular Fibrillation	227	>97%	>95%	Meets the AAMI DF80 requirement and AHA recommendation <sup>2</sup> of Sensitivity > 90%
Shockable Rhythm – Ventricular Tachycardia	101	99%	>97%	Meets the AAMI DF80 requirement and AHA recommendation <sup>2</sup> of Sensitivity > 75%
Non-Shockable Rhythm – Normal Sinus Rhythm	213	100%	100%	Meets the AAMI DF80 requirement of Specificity >95% and the AHA recommendation <sup>2</sup> of Specificity > 99%
Non-Shockable Rhythm – Asystole	113	100%	100%	Meets the AAMI DF80 requirement and the AHA recommendation <sup>2</sup> of Specificity > 95%
Non-Shockable Rhythm – All other non-shockable rhythms	248	>99%	>98%	Meets the AAMI DF80 requirement and the AHA recommendation <sup>2</sup> of Specificity > 95%

1. From Defibtech ECG Rhythm Databases.

2. Automatic External Defibrillators for Public Access Defibrillation: Recommendations for Specifying and Reporting Arrhythmia Analysis Algorithm Performance, Incorporating New Waveforms, and Enhancing Safety. American Heart Association (AHA) Task Force on Automatic External Defibrillation, Subcommittee on AED Safety and Efficacy. *Circulation*, 1997;95:1677-1682.

3. Schneider T, Martens PR, Paschen H, et al. Multicenter, randomized, controlled trial of 150 J biphasic shocks compared with 200- to 360-J monophasic shocks in the resuscitation of out-of-hospital cardiac arrest victims. *Circulation* 2000;102:1780-1787.

**Note:** Additional information available upon request.

## 11.2 Battery Packs

Use only Defibtech battery packs in the DDU-2400/2450 AED.

### DBP-2003 and DBP-2013 Battery Packs

Category	Specification
Model number	DBP-2003, DBP-2013 (Aviation)
Main battery type	12VDC, 2800 mAh, Lithium/Manganese Dioxide. Disposable, recyclable, non-rechargeable.
Capacity	125 shocks or 8 hours of continuous operation.*
Charge time	AED Mode: <ul style="list-style-type: none"> <li>• 4 seconds or less (from shock advised)*</li> </ul> Manual Mode: <ul style="list-style-type: none"> <li>• 9 seconds or less (150 J)**</li> <li>• 12 seconds or less (200 J)**</li> </ul>
Standby-life (installed in unit)	4 years*

\*Typical, new battery, at 25°C

\*\*typical, new battery depleted by 6 shocks, at 25°C

## 11.3 Self-Adhesive Defibrillation Pads

Use only Defibtech defibrillation pads with your DDU-2400/2450 AED. Defibtech self-adhesive defibrillation pads have the following characteristics:

Model number	DDP-2001	DDP-2002 and DDP-2003
Type	Adult	Child/Infant < 8 years < 55 lbs. (25kgs)
Intended use	Disposable	Disposable
Adhesion	Self-adhesive	Self-adhesive
Active gel surface area	77 cm <sup>2</sup> each (nominal)	50 cm <sup>2</sup> each (nominal)
Cable/connector type	Integrated	Integrated
Cable length	122 cm (typical)	122 cm (typical)
Expiration date	2.5 years from date of manufacture	2.5 years from date of manufacture

**Note:** In the event of a suspected pad defect, the pads should be clearly marked “Not for Use” and returned to Defibtech, LLC for analysis. (Refer to [Chapter 14](#) of this manual for contact information regarding returns.)

## 11.4 ECG Monitoring Adaptor / Cable (Optional)

Model number	DAC-2020 and DAC-2021			
Patient connection	Type CF, fully defibrillation-protected			
Cable length	2 meters			
Patient lead wire designation	<b>Lead type</b>	<b>DAC-2020 (AHA)</b>	<b>DAC-2021 (IEC)</b>	<b>Placement</b>
	Positive	Red - LL	Green - F	Left leg
	Negative	White - RA	Red - R	Right arm
	Reference	Black - LA	Yellow - L	Left arm
Typical lead connection	Lead II			
Performance	Meets <a href="#">environmental specifications</a> for DDU-2400/2450 AEDs			

## 11.5 Event Documentation

### Internal Event Record

Critical ECG segments and rescue event parameters are recorded (greater than 60 minutes) and can be downloaded to a removable data card.

### Removable Storage (optional)

Up to 30 hours of ECG and event data storage (no audio option) or up to 3 hours of audio (audio option). ECG and event storage on a removable data card. Actual length of storage is dependent on card capacity.

## 11.6 Defibtech Event Viewer

DefibView II is a PC-based application program that allows review of ECG data and other patient and device performance parameters after an emergency event.

DefibView II runs on various Windows platforms including Windows XP and newer versions. Minimum system requirements for adequate performance are as follows:

- Pentium 4 Processor
- 512 MB System Memory
- 1 GB free space on hard disk
- USB 1.0 connectivity

## 11.7 Recycling Information

At the end of useful life, recycle the defibrillator and its accessories.

### Recycling Assistance

For recycling assistance contact your local Defibtech distributor.  
Recycle in accordance with local and national regulations.

### Preparation For Recycling

Items should be clean and contaminant-free prior to being recycled.  
When recycling used disposable electrodes, follow local clinical procedures.

### Packaging For Recycling

Packaging should be recycled in accordance with local and national requirements.

## 11.8 Notice To European Union Customers



The crossed-out wheeled bin symbol on this device indicates that this equipment has been put on the market after 13 August 2005, and is included in the scope of the directive 2002/96/EEC on Waste Electrical and Electronic Equipment (WEEE) and of the national decree(s), which transpose provisions of such directive.

At the end of its lifetime, this device can only be disposed of in compliance with the provisions of the above-mentioned European directive (and following possible revisions) as well as with the corresponding national regulation. Severe penalties are possible for unauthorized disposal.

Electrical and Electronic Equipment (EEE) may contain polluting components and hazardous substances, the accumulation of which could pose serious risk for the environment and human health. It is for this reason that local administrations provide regulations, which encourage reuse and recycling, and prohibit the disposal of WEEE as unsorted municipal waste and require the collection of such WEEE separately (at specifically authorized treatment facilities). Manufacturer and authorized distributors are required to supply information about a safe treatment and disposition of the specific device.

You may also return this equipment to your distributor when purchasing a new one. As for reuse and recycling, notwithstanding the limits imposed by the nature and the use of this device, the manufacturer will do its best to develop recovery processes. Please contact the local distributor for information.

# 12 Electromagnetic Conformity

## 12.1 Guidance And Manufacturer's Declaration

The essential performance of the DDU-2400/2450 AED is successful delivery of defibrillation therapy and accurate differentiation between shockable and nonshockable rhythms.

DDU-2400/2450 AEDs are intended for use within the electromagnetic environment specified below. The customer or the user of the DDU-2400/2450 AED should assure that it is used within the stated environmental specifications.

### ELECTROMAGNETIC EMISSIONS

<b>Emissions test</b>	<b>Compliance</b>	<b>Electromagnetic environment – guidance</b>
RF emissions CISPR 11 CISPR 22 FCC Part 15	Group 1 Class B Class B Class B	The DDU-2400/2450 AED uses RF energy only for its internal function. Therefore, its RF emissions are very low and are not likely to cause any interference in nearby electronic equipment.
Harmonic emissions IEC 61000-3-2	Not applicable	Battery operated equipment
Voltage fluctuations/flicker emissions IEC 61000-3-3	Not applicable	Battery operated equipment

### ELECTROMAGNETIC IMMUNITY

<b>Immunity test</b>	<b>IEC 60601 test level</b>	<b>Compliance level</b>	<b>Electromagnetic environment – guidance</b>
Electrostatic discharge (ESD) IEC 60601-4-2	±8 kV contact ±15 kV air	±8 kV contact ±15 kV air	There are no special requirements with respect to electrostatic discharge.
Electrical fast transient/burst IEC 61000-4-4	±2 kV for power line supply lines ±1 kV for input/output lines	Not applicable	Battery operated equipment
Surge IEC 61000-4-5	±1 kV line(s) to line(s) ±2 kV line(s) to earth	Not applicable	Battery operated equipment
Voltage dips, short interruptions and voltage variations on power supply input lines IEC 61000-4-11	Not applicable	Not applicable	Battery operated equipment
Power frequency (50/60 Hz) magnetic field IEC 61000-4-8	3 A/m	3 A/m	Power frequency magnetic fields should not be greater than levels characteristic of a typical location in a commercial or hospital environment.

<b>Immunity test</b>	<b>IEC 60601 test level</b>	<b>Compliance level</b>	<b>Electromagnetic environment – guidance</b>
Radiated RF IEC 61000-4-3	10 V/m 80 MHz to 2.5 GHz  80% 5Hz AM Modulation	10 V/m	Portable and mobile RF communications equipment should be used no closer to any part of the DDU-2400/2450, including cables, than necessary. The recommended separation distance calculated from the equation applicable to the frequency of the transmitter is shown in the following table.
			 Interference may occur in the vicinity of equipment marked with this symbol.
<p><b>Note 1:</b> At 80 MHz and 800 MHz, the higher frequency range applies.</p> <p><b>Note 2:</b> These guidelines may not apply in all situations. Electromagnetic propagation is affected by absorption and reflection from structures, objects and people.</p> <p>The ISM (industrial, scientific and medical) bands between 150 kHz and 80 MHz are 6,765 MHz to 6,795 MHz; 13,553 MHz to 13,567; 26,957 MHz to 27,283 MHz; and 40,66 MHz to 40,70 MHz.</p> <p>Field strengths from fixed transmitters, such as base stations for radio (cellular/cordless) telephones and land mobile radios, amateur radio, AM and FM radio broadcast and TV broadcast cannot be predicted theoretically with accuracy. To assess the electromagnetic environment due to fixed RF transmitters, an electromagnetic site survey should be considered. If the measured field strength in the location in which the DDU-2400/2450 is used exceeds the applicable RF compliance level above, the DDU-2400/2450 should be observed to verify normal operation. If abnormal performance is observed additional measures may be necessary, such as reorienting or relocating the DDU-2400/2450 AED.</p>			

### Separation Distances

DDU-2400/2450 AEDs are intended for use in an electromagnetic environment in which radiated RF disturbances are controlled. The customer or the user of a DDU-2400/2450 AED can help prevent electromagnetic interference by maintaining a minimum distance between portable and mobile RF communications equipment (transmitters) and the DDU-2400/2450 AED as recommended below, according to the maximum output of the communications equipment.

<b>Recommended separation distances between portable and mobile RF communications equipment and DDU-2400/2450 AEDs</b>		
<b>Rated maximum output power of transmitter (W)</b>	<b>Separation distance according to frequency of transmitter (m)</b>	
	<b>80 MHz to 800 MHz</b>	<b>800 MHz to 2.5 GHz</b>
	<b><math>d = 1.2\sqrt{P}</math></b>	<b><math>d = 2.3\sqrt{P}</math></b>
0.01	0.12	0.23
0.1	0.38	0.73
1	1.20	2.30
10	3.79	7.27
100	12.00	23.00

## Separation Distances (continued)

For transmitters rated at a maximum output power not listed above, the recommended separation distance  $d$  in meters (m) can be determined using the equation applicable to the frequency of the transmitter, where  $P$  is the maximum output power rating of the transmitter in watts (W) according to the transmitter manufacturer.

**Note 1:** As 80 MHz and 800 MHz, the separation distance for the higher frequency range applies.

**Note 2:** The ISM (industrial, scientific and medical) bands between 150 kHz and 80 MHz are 6,765 MHz to 6,795 MHz; 13,553 MHz to 13,567; 26,957 MHz to 27,283 MHz; and 40,66 MHz to 40,70 MHz.

**Note 3:** An additional factor of 10/3 is used in calculating the recommended separation distance for transmitters in the ISM frequency bands between 150 kHz and 80 MHz and in the frequency range 80 MHz to 2.5 GHz to decrease the likelihood that mobile/portable communications equipment could cause interference if it is inadvertently brought into patient areas.

**Note 4:** These guidelines may not apply in all situations. Electromagnetic propagation is affected by absorption and reflection from structures, objects and people.

## Regulatory Compliance

Changes or modifications of this product, not expressly approved by Defibtech, may void the user's authority to operate the equipment.

This device complies with part 15 of the FCC Rules and Industry Canada Radio Standard RSS-210. Operation is subject to the following two conditions:

- (1) This device may not cause harmful interference, and
- (2) This device must accept any interference received, including interference that may cause undesired operation.

















This equipment has been tested and found to comply with the limits for a Class B digital device, pursuant to part 15 of the FCC Rules. These limits are designed to provide reasonable protection against harmful interference in a residential installation. This equipment generates, uses and can radiate radio frequency energy and, if not installed and used in accordance with the instructions, may cause harmful interference to radio communications. However, there is no guarantee that interference will not occur in a particular installation. If this equipment does cause harmful interference to radio or television reception, which can be determined by turning the equipment off and on, the user is encouraged to try to correct the interference by one or more of the following measures:

- Reorient or relocate the receiving antenna.
- Increase the separation between the equipment and receiver.
- Connect the equipment into an outlet on a circuit different from that to which the receiver is connected.
- Consult the dealer or an experienced radio/TV technician for help.













## CE Marking And European Union Compliance – Radio Transmitter

Defibtech, LLC declares that the DDU-2400/2450 AED radio transmitter is in compliance with the essential requirements and other relevant provisions of Directive 1999/5/EC. Applicable standards are listed in the "Environmental" section in Chapter 11 of this manual.

## 13 Glossary Of Symbols

Symbol	Meaning
	High voltage present.
	SHOCK Button – Delivers defibrillation shock to the patient when the device is ready to shock.
	ON/OFF Button <ul style="list-style-type: none"> <li>• Turns the device ON when it is OFF.</li> <li>• Turns the device OFF when it is ON.</li> </ul>
	Caution, consult accompanying documents.
	Do not expose to high heat or open flame. Do not incinerate.
	Recyclable.
	Consult operating instructions.
	Do not damage or crush.
	Follow proper disposal procedures.
	Meets the requirements of the European Medical Device Directive. <b>Note:</b> XXXX represents the identification number of the notified body.
	Temperature limitation.
	Use by (yyyy-mm).
	Defibrillation proof - Can withstand the effects of an externally applied defibrillation shock. Internally powered with defibrillator-proof BF-type patient applied parts (per EN 60601-1)
	Manufacturer.
	Date of manufacture.
	Do not reuse.
	For USA users only.

## Glossary Of Symbols (continued)

Symbol	Meaning
	Catalogue number.
	Keep dry.
	Handle with care.
	Transportation and storage requirements. See environmental requirements.
	Authorized European Representative.
	Does not contain latex.
	Lot number.
IP55	Dust protected; Protected against water jets.
	Classified by TUV Rheinland of NA with respect to electric shock, fire, and mechanical hazard only in accordance with UL 60601-1, CAN/CSA C22.2 No.601.1-M90, IEC 60601-1, and IEC 60601-2-4. Conforms to UL Standard UL 60601-1. Certified to CAN/CSA Standard C22.2 No. 601.1-M90.
	Serial number.
	Lithium Manganese Dioxide Battery.
	Product is not sterile.
	Defibrillation proof - Can withstand the effects of an externally applied defibrillation shock. Internally powered with defibrillator-proof CF-type patient applied parts (per EN 60601-1).



# 14 Contacts

## Manufacturer

Defibtech, LLC  
741 Boston Post Road - Suite 201  
Guilford, CT 06437  
USA

Tel.: 1-(866) 333-4241 (Toll-free within North America)  
1-(203) 453-4507  
Fax: 1-(203) 453-6657

Emails:  
sales@defibtech.com (Sales)  
reporting@defibtech.com (Medical Device Reporting)  
service@defibtech.com (Service and Repair)

## European Authorized Representative

<b>EC</b>	<b>REP</b>
-----------	------------

Emergo Europe  
Molenstraat 15  
2513 BH The Hague  
The Netherlands  
Tel.: +31 70 345 8570  
Fax: +31 70 346 7299

Patents pending.

This product and its accessories are manufactured and sold under one or more of the following United States patents: D523,393, D548,346, D551,628.

This product and its accessories are manufactured and sold under license to at least one or more of the following United States patents: 5,591,213; 5,593,427; 5,601,612; 5,607,454; 5,611,815; 5,617,853; 5,620,470; 5,662,690; 5,735,879; 5,749,904; 5,749,905; 5,776,166; 5,800,460; 5,803,927; 5,836,978; 5,836,993; 5,879,374; 6,016,059; 6,047,212; 6,075,369; 6,438,415; 6,441,582.